

# İÇİNDEKİLER / INDEX

<b>TAŞ DOKU / STONE TEXTURE</b>	<b>18-19</b>
Belgium Stone Outdoor	20-21
Quartzite Outdoor	22
Hardy Outdoor	23
Resolute Outdoor	24-25
İstanbul	26-27
Milano	28-31
Belgium Stone	32
Rusty	33-35
Terrazzo	36-39

<b>BETON DOKU / CONCRETE TEXTURE</b>	<b>40-41</b>
Cement	42-43
Neostone	44-45
Petra	46-47
Urban	48-49

<b>MERMER DOKU / MARBLE TEXTURE</b>	<b>50-51</b>
Nat. Black Marble	52-53
Black Marble	54
Bergama	55

<b>AHŞAP DOKU / WOOD TEXTURE</b>	<b>56-57</b>
Classwood	58
Linewood	59
Monte Verde	60-62
Sagano	63-67
Sagano Outdoor	68
Daintree	69

<b>DÜZ RENK / MONO COLOR</b>	<b>70-71</b>
Granito	72-73
Kripton	74-75
Rock	76-79
Venüs	80-82
Antiasit	83
Granit Krem	83
Havuz	84
Ral	85

<b>SERASTEP OUTDOOR (2 cm)</b>	<b>86-87</b>
<b>SERASTEP</b>	<b>88-95</b>

<b>Teknik Bilgiler ve Özellikleri</b>	<b>96-107</b>
Technical Information & Characteristics	

<b>Yapı Kimyasalları</b>	<b>108-146</b>
Construction Chemicals	

<b>Referans Projeler</b>	<b>147-151</b>
Reference Projects	

**\*Katalogda yer alan tüm ürünler fullbody veya colorbody bünyeye sahip teknik porselenlerdir. (Sayfa 83-85 arasında yer alan “granit krem”, “havuz” ve “ral” dışında.)**

# 120x120

Belgium Stone  
Quarzite  
Hardy  
Resolute  
İstanbul  
Cement  
Petra  
Urban  
Black Marble  
Nat. Black Marble  
Bergama

# 60x120

İstanbul  
Milano  
Belgium Stone  
Rusty  
Terrazzo  
Cement  
Petra  
Neostone  
Urban  
Black Marble  
Nat.Black Marble  
Bergama  
Monte verde  
Sagano  
Granito  
Kripton  
Venüs  
Rock

# 30x180

Classwood  
Linewood

# 40x120

Belgium Stone  
Quarzite  
Hardy  
Resolute  
Sagano Outdoor

# 30x120 20x120

Monte Verde  
Sagano  
Daintree

# 60x60

Belgium Stone  
Quarzite  
Hardy  
Resolute  
İstanbul  
Milano  
Rusty  
Terrazzo  
Cement  
Petra  
Neostone  
Urban  
Nat. Black Marble  
Granito  
Venüs  
Granit Krem

# 40x40

Granit Krem

# 30x60

Granito

# 30x30

Antiasit

# 20x20

Ral

## DAYANIKLIDIR, KIRILMAZ, ÇİZİLMEZ

Seramiksan yüksek performanslı teknik karolar; darbelere ve aşırı yüke karşı dayanıklılığı ile fonksiyonun ön planda olduğu kamusal ve ticari alanlarda profesyonel çözümler sunar. Hastane, alışveriş merkezi, hotel, havalimanı gibi yoğun trafiğin ve aşınmanın olduğu zeminlerde güvenle kullanılır.

## DURABLE, SHATTER-PROOF, SCRATCH-PROOF

High performance technical tiles by Seramiksan offers professional solutions in public and commercial areas where its function is at the forefront thanks to its resistance to the impacts and heavy weight. They can be used trustfully in the floors where intense traffic and wear exist like in hospitals, shopping malls, hotels and airports.



## **HİJYENİKTİR, KOLAY TEMİZLENİR, KİMYASALLARDAN ETKİLENMEZ**

Seramiksın yüksek performanslı teknik karolar; hijyeniktir, kolay temizlenebilir ve ağır temizlik kimyasallarından etkilenmez. Bu sayede konutlar, eğitim kurumları, hastaneler ve sık temizlik gerektiren yoğun trafikli mekânlar için hijyen özelliği ile güvenle kullanılabilir.

## **HYGIENIC, CLEANABLE AND RESISTANT TO THE CHEMICALS**

High performance technical tiles by Seramiksın are not affected by heavy cleaning chemicals. There fore, they can be used safely thanks to its hygienic feature, in homes, educational establishments, hospitals and high-traffic locations which require frequent cleaning.



## DIŐ ETKENLERDEN ETKİLENMEZ, UZUN ÖMÜRLÜDÜR

Seramiksın yüksek performanslı teknik karolar; güneő, su, tuz ve klor gibi diő etkenlerden etkilenmezler. Bu nedenle havuz kenarında da rahatlıkla kullanılabilir. Renk ve desenlerinde solma olmaz, uzun ömürlüdür.

## CLOSE TO EFFECTS OF EXTERNAL FACTORS LONG-LASTING

High performance technical tiles by Seramiksın are not affected by external factors such as sun, water, salt and chlorine. Therefore, they can be used safely at pool sides. Their colors do not fade away and they are long-lasting.

# FARKLI KAYMAZLIK SINIFINDA ÜRÜNLER SUNAR

Seramiksan yüksek performanslı teknik karolar; farklı kaymazlık dereceleri ile kaymaya karşı etkili bir koruma sağlayan ürünler sunuyor. Farklı kaymazlık dereceleriyle evlerde, profesyonel mekanlarda özellikle kaymazlık özelliğinin çok kritik olduğu endüstriyel alanlarda uzun yıllar güvenle kullanılabilir.

## PRESENTS PRODUCTS IN DIFFERENT ANTISLIP CLASS

High performance technical tiles by Seramiksan offer products which provide high protection against slipping thanks to its different antislip degrees. They can be used safely for a long time at houses, professional areas especially at industrial areas where antislip property is very crucial.









2CM

## 2CM KALIN KAROLARI İLE FARK YARATIYOR

Seramixsan yüksek performanslı teknik karolar, outdoor (2cm kalın) ürünleri sayesinde fonksiyonelliğın ötesinde tasarımı ile de iç mekandan dış mekana geçişte bütünlük sağlıyor.

## DISTINCTIVE THANKS TO 2 CM THICK TILES

Besides its functionality, outdoor series (2 cm thickness) which takes place in high performance technical tiles by Seramixsan create coherence with its design in getting through external place to the internal place.



## DIŐ CEPHE KULLANIMINA UYGUN ZENGİN ÜRÜN ÇEŐİTLİLİĐİ SUNAR

Seramiksın yüksek performanslı teknik karolar; hava Őartlarına meydan okuyarak, sıcak ve soĐuk havadan ve sıcaklık deĐiŐimlerinden etkilenmez. YaĐmur, kar ve dona karŐı dayanıklı, diŐ cephe kullanıma uygun 120x120 cm, 60x120 cm ve 60x60 cm ebadında zengin ürün çeŐitliliĐi sunar.

## PROVIDES RICH PRODUCT DIVERSITY SUITABLE FOR USAGE IN FACADES

High performance technical tiles by Seramiksın are not affected by temperature changes and the weather conditions. They provide product diversity in 120x120cm, 60x120 cm and 60x60 sizes which are resistant to rain, snow and frost and suitable for usage in facades.



# TAŞ DOKU

## STONE TEXTURE

### 2cm Outdoor

- Belgium Stone
- Quarzite
- Hardy
- Resolute
- Istanbul
- Milano
- Belgium Stone
- Rusty
- Terrazzo

## BELGIUM STONE OUTDOOR



Ürün / Product	Ebat / Size (cm)	Birim / Unit (m <sup>2</sup> /Ad/kg)	Kutu / Box			Palet / Pallet		
			(Ad-Pcs)	(m <sup>2</sup> )	(kg)	(Kutu-Box)	(m <sup>2</sup> )	(kg)
Porselen Karo / Porcelain Tiles	120x120	m <sup>2</sup>	Kutusuz		60,2	15	21,6	951
	40x120	m <sup>2</sup>	Without Box		21,5	38	18,24	845
	60x60	m <sup>2</sup>	2	0,72	16,6	60	21,6	1.022





# BELGIUM STONE OUTDOOR

Porselen Karo / Porcelain Tile "UGL"



**2 cm Belgium Stone Outdoor**  
Antrasit / Anthracite

**120x120 cm / 48" x 48"** 910800

**40x120 cm / 16" x 48"** 910700

**60x60 cm / 24" x 24"** 910620

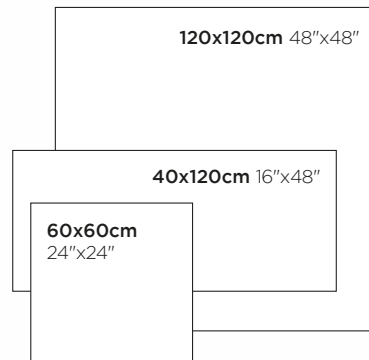



# QUARZITE OUTDOOR

Porselen Karo / Porcelain Tile "UGL"



## 2 cm Quarzite Outdoor

120x120 cm / 48" x 48" 911800

40x120 cm / 16" x 48" 911700

60x60 cm / 24" x 24" 911620

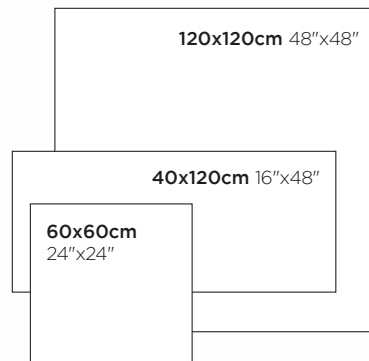

# HARDY OUTDOOR

Porselen Karo / Porcelain Tile "UGL"

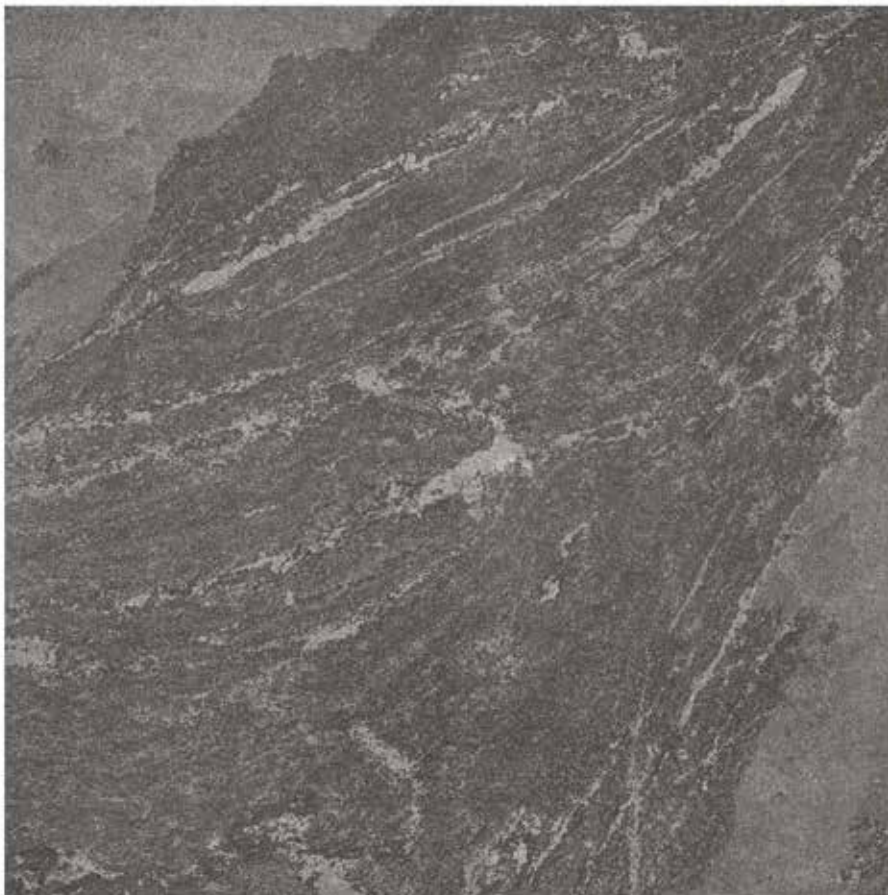

2 cm Hardy Outdoor

120x120 cm / 48" x 48" 919800

40x120 cm / 16" x 48" 919700

60x60 cm / 24" x 24" 919610

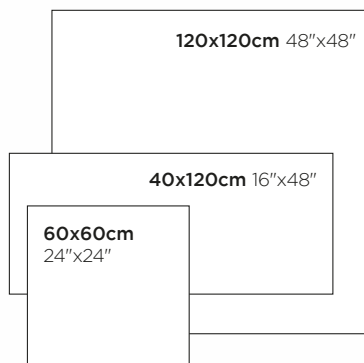



# RESOLUTE OUTDOOR

Porselen Karo / Porcelain Tile "UGL"



2 cm Resolute Dark Gri / Dark Grey

120x120 cm / 48" x 48" **914801**

40x120 cm / 16" x 48" **914701**

60x60 cm / 24" x 24" **914620**

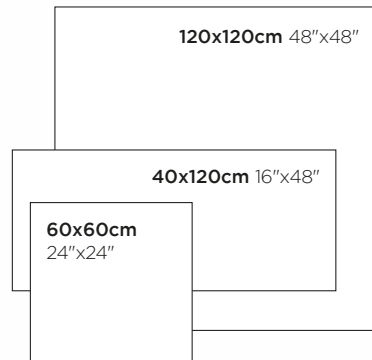

# RESOLUTE OUTDOOR

Porselen Karo / Porcelain Tile "UGL"

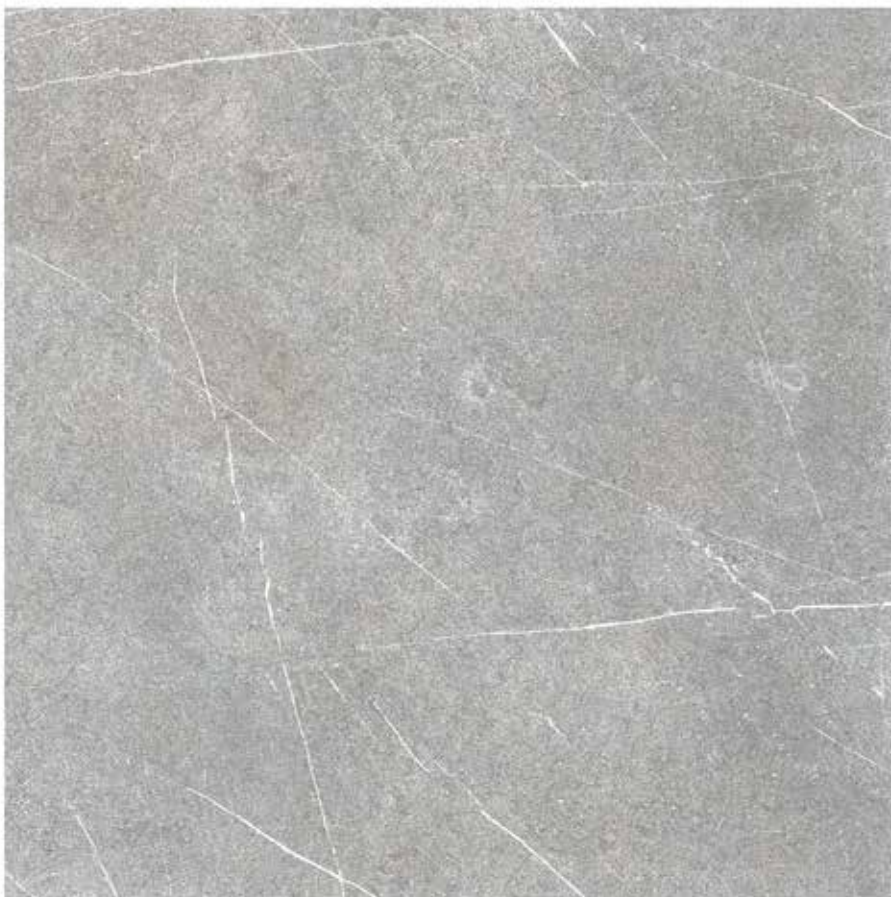

2 cm Resolute Gri / Grey

120x120 cm / 48" x 48" 914800

40x120 cm / 16" x 48" 914700

60x60 cm / 24" x 24" 914621

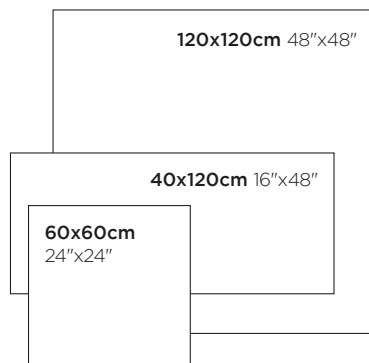



**İSTANBUL**  
Porselen Karo / Porcelain Tile "UGL"



Beyaz / White

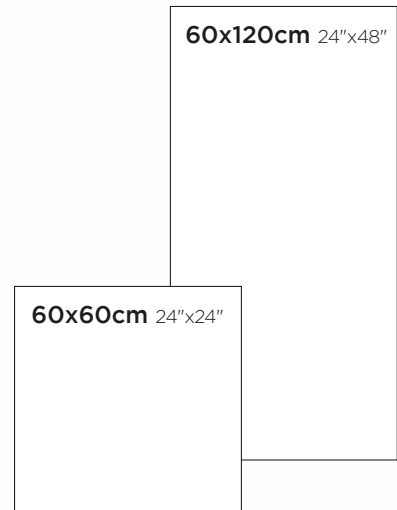

# İSTANBUL

Porselen Karo / Porcelain Tile "UGL"



Beyaz / White

227901  
60x120cm / 24"x48"

226901  
60x60cm / 24"x24"



Açık Gri / Light Grey

228911  
120x120cm / 48"x48"

227903  
60x120cm / 24"x48"

226903  
60x60cm / 24"x24"



Gri / Grey

227904  
60x120cm / 24"x48"

226904  
60x60cm / 24"x24"



Siyah / Black

227902  
60x120cm / 24"x48"

226902  
60x60cm / 24"x24"

Ürün / Product	Ebat / Size (cm)	Birim / Unit (m <sup>2</sup> /Ad/kg)	Kutu / Box			Palet / Pallet		
			(Ad-Pcs)	(m <sup>2</sup> )	(kg)	(Kutu-Box)	(m <sup>2</sup> )	(kg)
Porselen Karo / Porcelain Tiles	120x120	m <sup>2</sup>	1	1,44	36,3	30	43,2	1,100
	60x120	m <sup>2</sup>	2	1,44	36,2	29	41,76	1,080
	60x60	m <sup>2</sup>	4	1,44	33	30	43,2	1,020



**MILANO**  
GRİ / GREY







**MILANO**

Porselen Karo / Porcelain Tile "UGL"



Gri / Grey

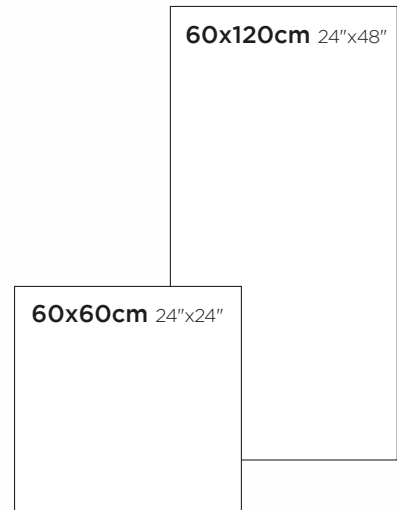

# MILANO

Porselen Karo / Porcelain Tile "UGL"



Beyaz / White

932904  
60x120cm / 24"x48"

932954  
60x60cm / 24"x24"



Gri / Grey

932901  
60x120cm / 24"x48"

932951  
60x60cm / 24"x24"



Bej / Beige

932902  
60x120cm / 24"x48"

932952  
60x60cm / 24"x24"



Siyah / Black

932903  
60x120cm / 24"x48"

932953  
60x60cm / 24"x24"

Ürün / Product	Ebat / Size (cm)	Birim / Unit (m <sup>2</sup> /Ad/kg)	Kutu / Box			Palet / Pallet		
			(Ad-Pcs)	(m <sup>2</sup> )	(kg)	(Kutu-Box)	(m <sup>2</sup> )	(kg)
Porselen Karo / Porcelain Tiles	60x120	m <sup>2</sup>	2	1,44	36,2	29	41,76	1,080
	60x60	m <sup>2</sup>	4	1,44	33	30	43,2	1,020



# BELGIUM STONE

Porselen Karo / Porcelain Tile "UGL"



## Belgium Stone

910210  
120x120cm / 48"x48"

910910  
60x120cm / 24"x48"

910610  
60x60cm / 24"x24"

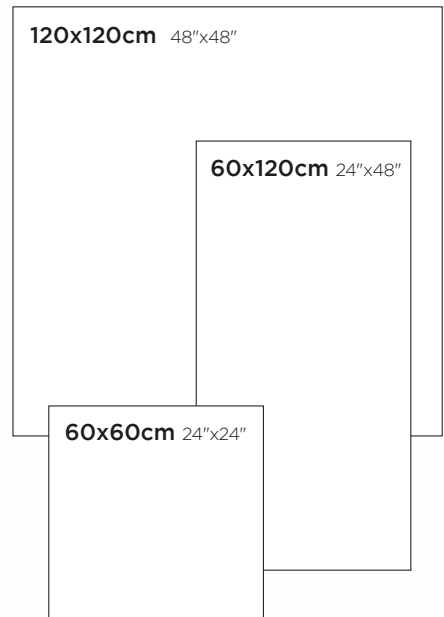



**RUSTY**

Porselen Karo / Porcelain Tile "UGL"



**Rusty Siyah / Rusty Black**

**879211**  
**60x120cm / 24"x48"**

**879911**  
**60x60 cm / 24"x24"**

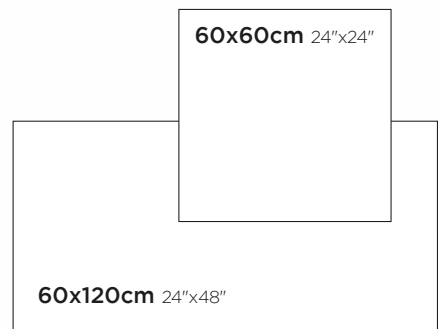



## RUSTY

Ürün / Product	Ebat / Size (cm)	Birim / Unit (m <sup>2</sup> /Ad/kg)	Kutu / Box			Palet / Pallet		
			(Ad-Pcs)	(m <sup>2</sup> )	(kg)	(Kutu-Box)	(m <sup>2</sup> )	(kg)
Porselen Karo / Porcelain Tiles	60x120	m <sup>2</sup>	2	1,44	36	29	41,76	1,080
	60x60	m <sup>2</sup>	4	1,44	32,33	30	43,2	1,020



**RUSTY**

Porselen Karo / Porcelain Tile "UGL"



Rusty

879201  
60x120cm / 24"x48"

879901  
60x60 cm / 24"x24"

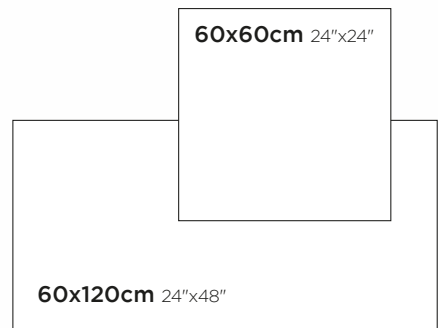









**TERRAZZO**  
Porselen Karo / Porcelain Tile "UGL"



Terrazzo

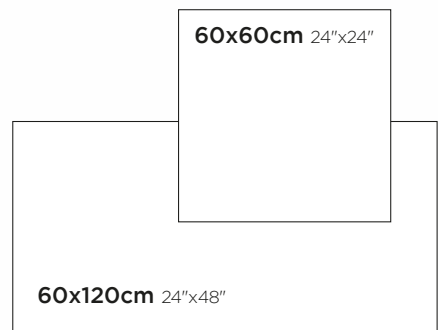

# TERRAZZO

Porselen Karo / Porcelain Tile "UGL"



**Terrazzo Mono Kemik**  
Full Lappato  
Sirli Porselen Karo



**878251**  
60x120cm / 24"x48"

**878951**  
60x60 cm / 24"x24"



**Terrazzo Mono Gri**  
Full Lappato  
Sirli Porselen Karo



**878252**  
60x120cm / 24"x48"

**878952**  
60x60 cm / 24"x24"



**Terrazzo Mono Antrasit**  
Full Lappato  
Sirli Porselen Karo



**878253**  
60x120cm / 24"x48"

**878953**  
60x60 cm / 24"x24"



**Terrazzo Mat**



**878201**  
60x120cm / 24"x48"

**878901**  
60x60 cm / 24"x24"

**Terrazzo Mono Kemik**  
Semi Lappato  
Sirli Porselen Karo  
Glazed Porcelain Tile



**878284**  
60x120cm / 24"x48"

**878984**  
60x60 cm / 24"x24"

**Terrazzo Mono Gri**  
Semi Lappato  
Sirli Porselen Karo  
Glazed Porcelain Tile



**878282**  
60x120cm / 24"x48"

**878982**  
60x60 cm / 24"x24"

**Terrazzo Mono Antrasit**  
Semi Lappato  
Sirli Porselen Karo  
Glazed Porcelain Tile



**878283**  
60x120cm / 24"x48"

**878983**  
60x60 cm / 24"x24"

**Terrazzo Semi Lappato**  
Sirli Porselen Karo  
Glazed Porcelain Tile



**878281**  
60x120cm / 24"x48"

**878981**  
60x60 cm / 24"x24"

Ürün / Product	Ebat / Size (cm)	Birim / Unit (m <sup>2</sup> /Ad/kg)	Kutu / Box			Palet / Pallet		
			(Ad-Pcs)	(m <sup>2</sup> )	(kg)	(Kutu-Box)	(m <sup>2</sup> )	(kg)
Porselen Karo / Porcelain Tiles	60x120	m <sup>2</sup>	2	1,44	36	29	41,76	1,080
	60x60	m <sup>2</sup>	4	1,44	32,33	30	43,2	1,020



# BETON DOKU

## CONCRETE TEXTURE

Cement  
Neostone  
Petra  
Urban



**CEMENT**

Porselen Karo / Porcelain Tile "UGL"



Antrasit / Anthracite

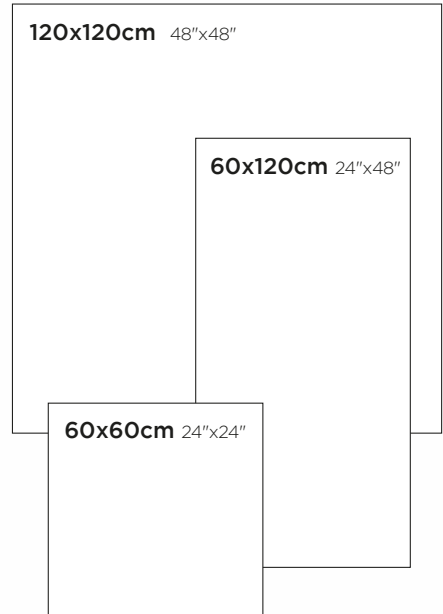

# CEMENT Porselen Karo / Porcelain Tile "UGL"



**Bej / Beige**

**261922**  
120x120cm / 48"x48"

**261902**  
60x120cm / 24"x48"

**261962**  
60x60 cm / 24"x24"



**Bej Semi Lappato**  
Beige Semi Lappato

**261912**  
60x120cm / 24"x48"

**261972**  
60x60 cm / 24"x24"



**Gri / Grey**

**261920**  
120x120cm / 48"x48"

**261900**  
60x120cm / 24"x48"

**261960**  
60x60 cm / 24"x24"



**Gri Semi Lappato**  
Grey Semi Lappato

**261910**  
60x120cm / 24"x48"

**261970**  
60x60 cm / 24"x24"



**Koyu Gri / Dark Grey**

**261921**  
120x120cm / 48"x48"

**261901**  
60x120cm / 24"x48"

**261961**  
60x60 cm / 24"x24"



**Koyu Gri Semi Lappato**  
Dark Gri Semi Lappato

**261911**  
60x120cm / 24"x48"

**261971**  
60x60 cm / 24"x24"



**Antrasit / Anthracite**

**261923**  
120x120cm / 48"x48"

**261903**  
60x120cm / 24"x48"

**261963**  
60x60 cm / 24"x24"



**Antrasit Semi Lappato**  
Anthracite Semi Lappato

**261913**  
60x120cm / 24"x48"

**261973**  
60x60 cm / 24"x24"

Ürün / Product	Ebat / Size (cm)	Birim / Unit (m <sup>2</sup> /Ad/kg)	Kutu / Box			Palet / Pallet		
			(Ad-Pcs)	(m <sup>2</sup> )	(kg)	(Kutu-Box)	(m <sup>2</sup> )	(kg)
Porselen Karo / Porcelain Tiles	60x120	m <sup>2</sup>	2	1,44	36,2	29	41,76	1,080
	60x60	m <sup>2</sup>	4	1,44	33	30	43,2	1,020



**NEOSTONE**  
Porselen Karo / Porcelain Tile "UGL"



Koyu Gri / Dark Grey

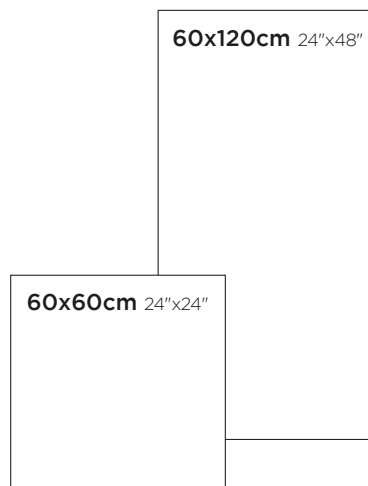



# NEOSTONE Porselen Karo / Porcelain Tile "UGL"



**Gri / Grey**

**252901**  
60x120cm / 24"x48"

**252961**  
60x60 cm / 24"x24"



**Koyu Gri / Dark Grey**

**252902**  
60x120cm / 24"x48"

**252962**  
60x60 cm / 24"x24"



**Greige / Greige**

**252903**  
60x120cm / 24"x48"

**252963**  
60x60 cm / 24"x24"



**Antrasit / Anthracite**

**252904**  
60x120cm / 24"x48"

**252964**  
60x60 cm / 24"x24"

Ürün / Product	Ebat / Size (cm)	Birim / Unit (m <sup>2</sup> /Ad/kg)	Kutu / Box			Palet / Pallet		
			(Ad-Pcs)	(m <sup>2</sup> )	(kg)	(Kutu-Box)	(m <sup>2</sup> )	(kg)
Porselen Karo / Porcelain Tiles	60x120	m <sup>2</sup>	2	1,44	36,2	29	41,76	1,080
	60x60	m <sup>2</sup>	4	1,44	33	30	43,2	1,020



**PETRA**  
Porselen Karo / Porcelain Tile "UGL"



Gri / Grey

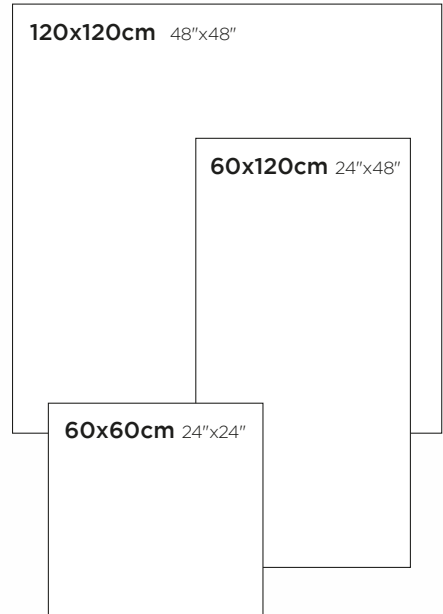

# PETRA Porselen Karo / Porcelain Tile "UGL"



**Gri / Grey**

**262921**  
120x120cm / 48"x48"

**262901**  
60x120cm / 24"x48"

**262961**  
60x60 cm / 24"x24"



**Koyu Gri / Dark Grey**

**262920**  
120x120cm / 48"x48"

**262900**  
60x120cm / 24"x48"

**262960**  
60x60 cm / 24"x24"



**Bej / Beige**

**262922**  
120x120cm / 48"x48"

**262902**  
60x120cm / 24"x48"

**262962**  
60x60 cm / 24"x24"



**Fildişi / Ivory**

**262923**  
120x120cm / 48"x48"

**262903**  
60x120cm / 24"x48"

**262963**  
60x60 cm / 24"x24"

Ürün / Product	Ebat / Size (cm)	Birim / Unit (m <sup>2</sup> /Ad/kg)	Kutu / Box			Palet / Pallet		
			(Ad-Pcs)	(m <sup>2</sup> )	(kg)	(Kutu-Box)	(m <sup>2</sup> )	(kg)
Porselen Karo / Porcelain Tiles	60x120	m <sup>2</sup>	2	1,44	36,2	29	41,76	1,080
	60x60	m <sup>2</sup>	4	1,44	33	30	43,2	1,020



# URBAN

Porselen Karo / Porcelain Tile "UGL"



Antrasit / Anthracite

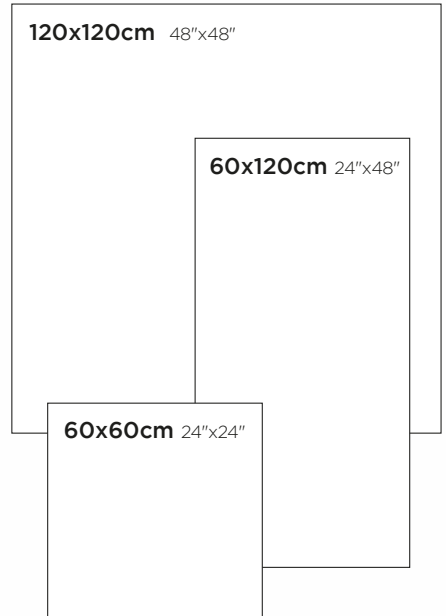

# URBAN Porselen Karo / Porcelain Tile "UGL"



**Gri / Grey**

**877101**  
**120x120cm / 48"x48"**

**877201**  
**60x120cm / 24"x48"**

**877901**  
**60x60 cm / 24"x24"**



**Antrasit / Anthracite**

**877111**  
**120x120cm / 48"x48"**

**877211**  
**60x120cm / 24"x48"**

**877911**  
**60x60 cm / 24"x24"**

**R<sup>11</sup>** **Antislip Gri / Antislip Grey**

**877102**  
**120x120 cm / 48"x48"**

**877202**  
**60x120cm / 24"x48"**

**877902**  
**60x60 cm / 24"x24"**

**R<sup>11</sup>** **Antislip Antrasit / Antislip Anthracite**

**877112**  
**120x120 cm / 48"x48"**

**877212**  
**60x120cm / 24"x48"**

**877912**  
**60x60 cm / 24"x24"**

Ürün / Product	Ebat / Size (cm)	Birim / Unit (m <sup>2</sup> /Ad/kg)	Kutu / Box			Palet / Pallet		
			(Ad-Pcs)	(m <sup>2</sup> )	(kg)	(Kutu-Box)	(m <sup>2</sup> )	(kg)
Porselen Karo / Porcelain Tiles	60x120	m <sup>2</sup>	2	1,44	36,2	29	41,76	1,080
	60x60	m <sup>2</sup>	4	1,44	33	30	43,2	1,020



# MERMER DOKU

## MARBLE TEXTURE

Nat. Black Marble  
Black Marble  
Bergama

# BLACK MARBLE



Ürün / Product	Ebat / Size (cm)	Birim / Unit (m <sup>2</sup> /Ad/kg)	Kutu / Box			Palet / Pallet		
			(Ad-Pcs)	(m <sup>2</sup> )	(kg)	(Kutu-Box)	(m <sup>2</sup> )	(kg)
Porselen Karo / Porcelain Tiles	120x120	m <sup>2</sup>	1	1,44	36,3	30	43,2	1,100
	60x120	m <sup>2</sup>	2	1,44	36,3	29	41,76	1,080





# NAT. BLACK MARBLE

Porselen Karo / Porcelain Tile "UGL"



## Nat. Black Marble

**934220**  
120x120cm 48"x48"

**934920**  
60x120cm 24"x48"

**934960**  
60x60cm 24"x24"

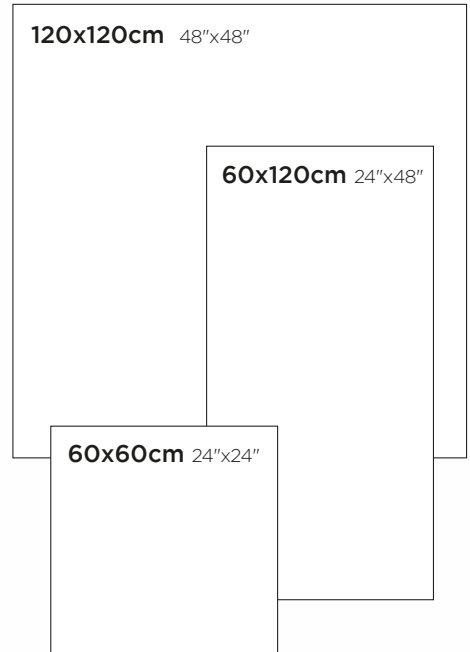

Nat. Black Marble



# BLACK MARBLE

Sırlı Porselen Karo / Glazed Porcelain Tile



Black Marble

## Black Marble

934201  
120x120cm / 48"x48"

934901  
60x120cm / 24"x48"

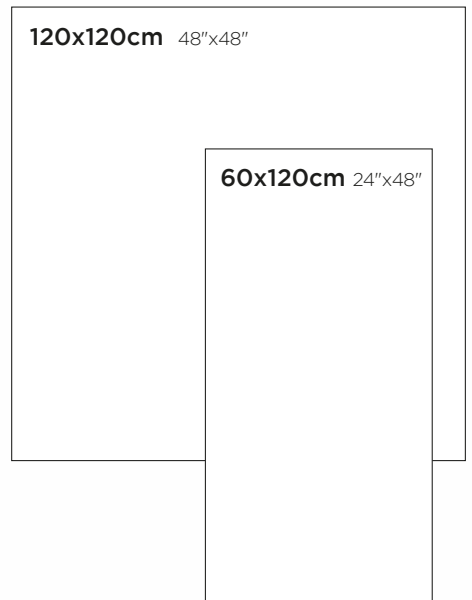



**BERGAMA**

Sırlı Porselen Karo / Glazed Porcelain Tile



Bergama

**Bergama**

**913210**  
**120x120cm 48"x48"**

**913910**  
**60x120cm 24"x48"**

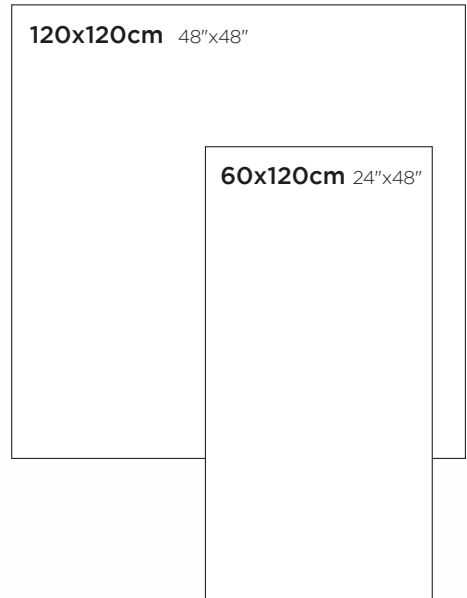



# AHŞAP DOKU

## WOOD TEXTURE

Classwood  
Linewood  
Monte Verde  
Sagano  
Daintree



**CLASSWOOD**  
Porselen Karo / Porcelain Tile "UGL"



**940384**  
30x180 cm / 12"x72"  
Badem / Almond



**940382**  
30x180 cm / 12"x72"  
Ceviz / Noce



**940381**  
30x180 cm / 12"x72"  
Çam / Pino



**940383**  
30x180 cm / 12"x72"  
Oak / Oak



**940385**  
30x180 cm / 12"x72"  
Kestane / Chestnut

Ürün / Product	Ebat / Size (cm)	Birim / Unit (m <sup>2</sup> /Ad/kg)	Kutu / Box (Ad-Pcs)	Kutu / Box (m <sup>2</sup> )	Adet - Pcs (kg)	Palet İçi Adet	Palet (m <sup>2</sup> )	Palet (kg)
Porselen Karo / Porcelain Tiles	30x180	m <sup>2</sup>	Kutusuz		14,5	61	32,94	926



# LINEWOOD

Porselen Karo / Porcelain Tile "UGL"



**944382**  
30x180 cm / 12"x72"  
Badem / Almond



**944381**  
30x180 cm / 12"x72"  
Ceviz / Noce



**944383**  
30x180 cm / 12"x72"  
Koyu Kahve / Dark Brown

Ürün / Product	Ebat / Size (cm)	Birim / Unit (m <sup>2</sup> /Ad/kg)	Kutu / Box (Ad-Pcs)	Kutu / Box (m <sup>2</sup> )	Adet - Pcs (kg)	Palet İçi Adet	Palet (m <sup>2</sup> )	Palet (kg)
Porselen Karo / Porcelain Tiles	30x180	m <sup>2</sup>	Kutusuz		14,5	61	32,94	926



## MONTE VERDE

Ürün / Product	Ebat / Size (cm)	Birim / Unit (m <sup>2</sup> /Ad/kg)	Kutu / Box			Palet / Pallet		
			(Ad-Pcs)	(m <sup>2</sup> )	(kg)	(Kutu-Box)	(m <sup>2</sup> )	(kg)
Porselen Karo / Porcelain Tiles	60x120	m <sup>2</sup>	2	1,44	36,3	29	41,76	1,080
	30x120	m <sup>2</sup>	3	1,08	25,6	40	43,2	1,050
	20x120	m <sup>2</sup>	4	0,96	23	36	34,56	850





# MONTE VERDE

Porselen Karo / Porcelain Tile "UGL"



**Gri / Grey**

**905901**  
**60x120 / 24"x48"**



**905300**  
**30x120 cm / 12"x48"**

**905401**  
**20x120 cm / 8"x48"**



**Zeytin / Olive**

**905902**  
**60x120 / 24"x48"**



**905301**  
**30x120 cm / 12"x48"**

**905402**  
**20x120 cm / 8"x48"**



# MONTE VERDE

Porselen Karo / Porcelain Tile "UGL"



Mix / Mix

**905900**  
60x120 / 24"x48"

**905303**  
30x120 cm / 12"x48"

**905400**  
20x120 cm / 8"x48"



Maun / Maun

**905903**  
60x120 / 24"x48"

**905302**  
30x120 cm / 12"x48"

**905403**  
20x120 cm / 8"x48"



# SAGANO

Porselen Karo / Porcelain Tile "UGL"



**Gri / Grey**

**904901**  
**60x120 / 24"x48"**

**904301**  
**30x120 cm / 12"x48"**

**904401**  
**20x120 cm / 8"x48"**



**Badem / Almond**

**904903**  
**60x120 / 24"x48"**

**904302**  
**30x120 cm / 12"x48"**

**904402**  
**20x120 cm / 8"x48"**







# SAGANO

Porselen Karo / Porcelain Tile "UGL"



**Ceviz / Noce**

**904902**  
**60x120 / 24"x48"**



**904303**  
**30x120 cm / 12"x48"**

**904403**  
**20x120 cm / 8"x48"**



**Oak / Oak**

**904904**  
**60x120 / 24"x48"**



**904304**  
**30x120 cm / 12"x48"**

**904404**  
**20x120 cm / 8"x48"**



# SAGANO

Porselen Karo / Porcelain Tile "UGL"



**Kestane / Chestnut**

**904905**  
**60x120 / 24"x48"**

**904300**  
**30x120 cm / 12"x48"**

**904400**  
**20x120 cm / 8"x48"**



Ürün / Product	Ebat / Size (cm)	Birim / Unit (m <sup>2</sup> /Ad/kg)	Kutu / Box			Palet / Pallet		
			(Ad-Pcs)	(m <sup>2</sup> )	(kg)	(Kutu-Box)	(m <sup>2</sup> )	(kg)
Porselen Karo / Porcelain Tiles	60x120	m <sup>2</sup>	2	1,44	36,3	29	41,76	1,080
	30x120	m <sup>2</sup>	3	1,08	25,6	40	43,2	1,050
	20x120	m <sup>2</sup>	4	0,96	23	36	34,56	850



# SAGANO OUTDOOR

Porselen Karo / Porcelain Tile "UGL"



904500  
40x120 cm / 16"x48"  
2 cm Sagano Outdoor Gri / 2 cm Sagano Outdoor Grey



904501  
40x120 cm / 16"x48"  
2 cm Sagano Outdoor Ceviz / 2 cm Sagano Outdoor Noce

Ürün / Product	Ebat / Size (cm)	Birim / Unit (m <sup>2</sup> /Ad/kg)	Kutu / Box (Ad-Pcs)	Kutu / Box (m <sup>2</sup> )	Adet - Pcs (kg)	Palet İçi Adet	Palet (m <sup>2</sup> )	Palet (kg)
Porselen Karo / Porcelain Tiles	40x120	m <sup>2</sup>	Kutusuz / Without Box		21,5	38	18,24	845





# DAINTREE

Porselen Karo / Porcelain Tile "UGL"



Beyaz / White

903300  
30x120 cm / 12"x48"

903400  
20x120 cm / 8"x48"

Ürün / Product	Ebat / Size (cm)	Birim / Unit (m <sup>2</sup> /Ad/kg)	Kutu / Box			Palet / Pallet		
			(Ad-Pcs)	(m <sup>2</sup> )	(kg)	(Kutu-Box)	(m <sup>2</sup> )	(kg)
Porselen Karo / Porcelain Tiles	30x120	m <sup>2</sup>	3	1,08	25,6	40	43,2	1.050
	20x120	m <sup>2</sup>	4	0,96	23	36	34,56	850

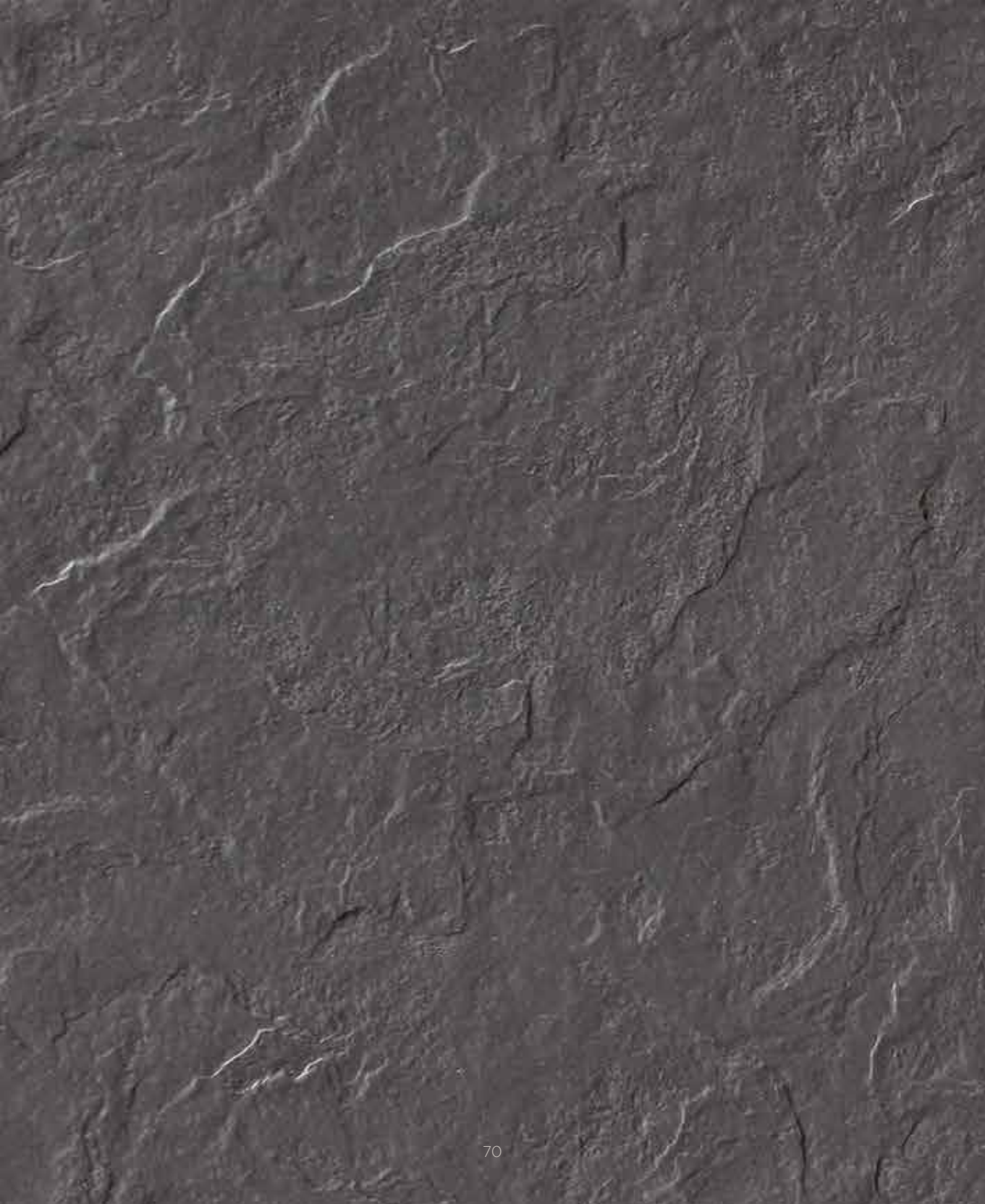

# DÜZ RENK

## MONO COLOR

Granito  
Kripton  
Rock  
Venüs  
Anti-Asit  
Granit Krem  
Ral



# GRANITO

Porselen Karo / Porcelain Tile "UGL"

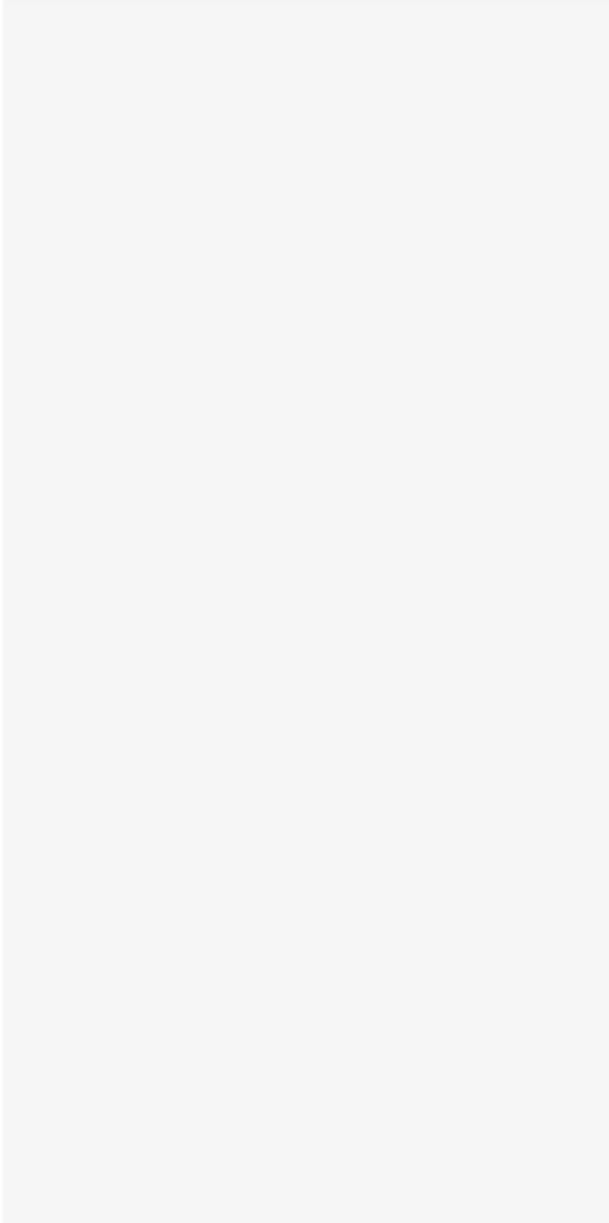

Süper Beyaz / Super White

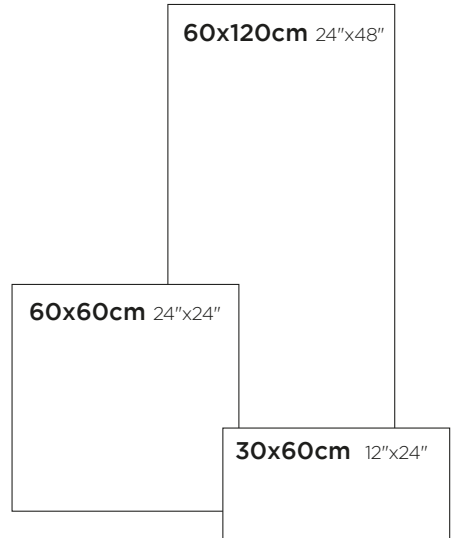

# GRANITO

Porselen Karo / Porcelain Tile "UGL"

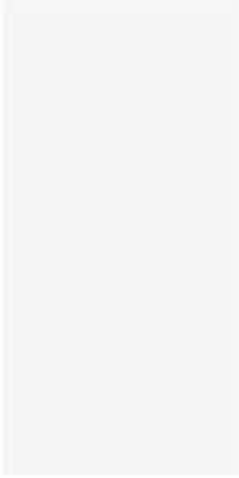

Süper Beyaz / Super White

924951  
60x120cm / 24"x48"

921951  
60x60cm / 24"x24"

920951  
30x60cm / 12"x24"



Kemik / Bone

924950  
60x120cm / 24"x48"

921950  
60x60cm / 24"x24"

920900  
30x60cm / 12"x24"



Süper Siyah / Super Black

924952  
60x120cm / 24"x48"

921952  
60x60cm / 24"x24"

920952  
30x60cm / 12"x24"

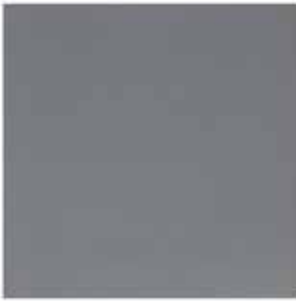

Gri / Grey

921953  
60x60cm / 24"x24"

Ürün / Product	Ebat / Size (cm)	Birim / Unit (m <sup>2</sup> /Ad/kg)	Kutu / Box			Palet / Pallet		
			(Ad-Pcs)	(m <sup>2</sup> )	(kg)	(Kutu-Box)	(m <sup>2</sup> )	(kg)
Porselen Karo / Porcelain Tiles	60x120	m <sup>2</sup>	2	1,44	36,3	29	41,76	1,080
	60x60	m <sup>2</sup>	4	1,44	33	30	43,2	1,020
	30x60	m <sup>2</sup>	8	1,44	32,7	32	46,08	1,100



# KRİPTON

Porselen Karo / Porcelain Tile "UGL"

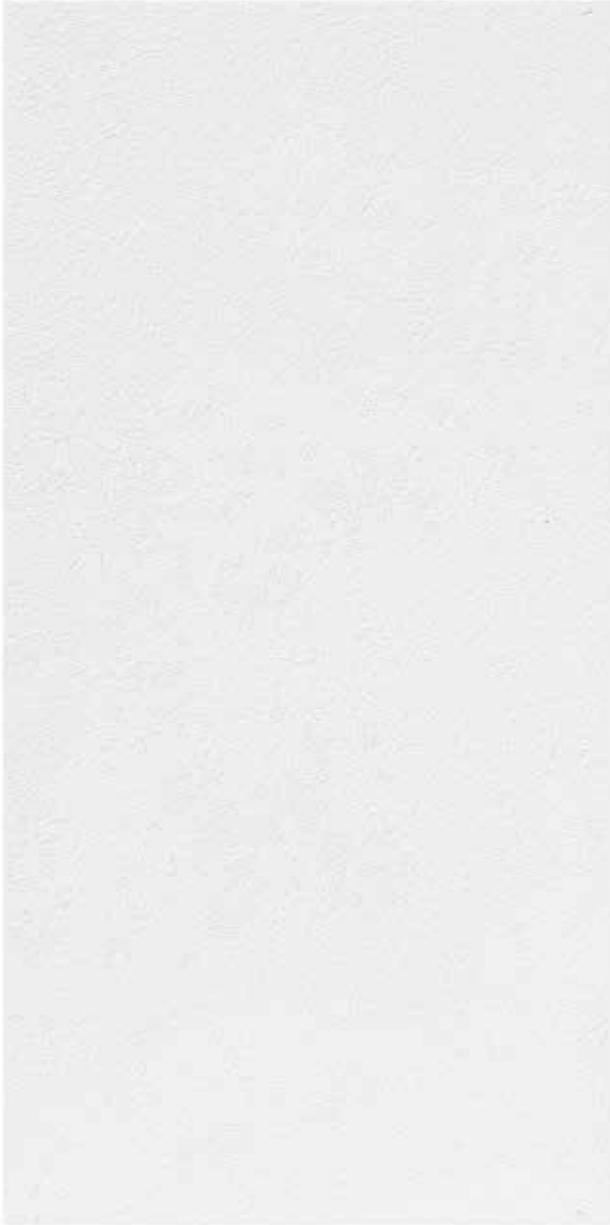

**60x120cm** 24"x48"

Süper Beyaz / Super White

# KRİPTON

Porselen Karo / Porcelain Tile "UGL"



**Beyaz / White**  
**930902**  
**60x120cm / 24"x48"**



**Bej / Beige**  
**930901**  
**60x120cm / 24"x48"**



**Cold Gri / Cold Grey**  
**930905**  
**60x120cm / 24"x48"**



**Cool Gri / Cool Grey**  
**930904**  
**60x120cm / 24"x48"**



**Koyu Gri / Dark Grey**  
**930903**  
**60x120cm / 24"x48"**



**Kahve / Brown**  
**930906**  
**60x120cm / 24"x48"**



**Koyu Kahve / Dark Brown**  
**930907**  
**60x120cm / 24"x48"**



**Siyah / Black**  
**930908**  
**60x120cm / 24"x48"**

Ürün / Product	Ebat / Size (cm)	Birim / Unit (m <sup>2</sup> /Ad/kg)	Kutu / Box			Palet / Pallet		
			(Ad-Pcs)	(m <sup>2</sup> )	(kg)	(Kutu-Box)	(m <sup>2</sup> )	(kg)
Porselen Karo / Porcelain Tiles	60x120	m <sup>2</sup>	2	1,44	36,3	29	41,76	1,080







**ROCK**



**ROCK** Porselen Karo / Porcelain Tile "UGL"



**60x120cm** 24"x48"

**Antrasit / Antracite**

# ROCK Porselen Karo / Porcelain Tile "UGL"



**Kemik / Bone**

**876211**  
**60x120cm / 24"x48"**



**Gri / Grey**

**876201**  
**60x120cm / 24"x48"**



**Antrasit / Antracite**

**876221**  
**60x120cm / 24"x48"**

Ürün / Product	Ebat / Size (cm)	Birim / Unit (m <sup>2</sup> /Ad/kg)	Kutu / Box			Palet / Pallet		
			(Ad-Pcs)	(m <sup>2</sup> )	(kg)	(Kutu-Box)	(m <sup>2</sup> )	(kg)
Porselen Karo / Porcelain Tiles	60x120	m <sup>2</sup>	2	1,44	36	29	41,76	1,080





# VENÜS

Porselen Karo / Porcelain Tile "UGL"



Bej / Beige

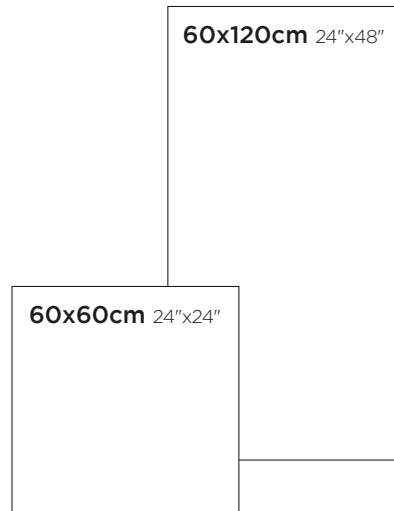

# VENÜS

Porselen Karo / Porcelain Tile "UGL"



**Beyaz / White**  
931902 60x120cm / 24"x48"  
931952 60x60 cm / 24"x24"



**Bej / Beige**  
931901 60x120cm / 24"x48"  
931951 60x60 cm / 24"x24"



**Dark Gri / Dark Grey**  
931903 60x120cm / 24"x48"  
931953 60x60 cm / 24"x24"



**Warm Gri / Warm Grey**  
931904 60x120cm / 24"x48"  
931954 60x60 cm / 24"x24"



**Siyah / Black**  
931905 60x120cm / 24"x48"  
931955 60x60 cm / 24"x24"

Ürün / Product	Ebat / Size (cm)	Birim / Unit (m <sup>2</sup> /Ad/kg)	Kutu / Box			Palet / Pallet		
			(Ad-Pcs)	(m <sup>2</sup> )	(kg)	(Kutu-Box)	(m <sup>2</sup> )	(kg)
Porselen Karo / Porcelain Tiles	60x120	m <sup>2</sup>	2	1,44	36,2	29	41,76	1,080
	60x60	m <sup>2</sup>	4	1,44	33	30	43,2	1,020



# ANTIASİT

Teknik Porselen / Vitrified Porcelain



**341221**  
**30x30 cm / 12"x12"**  
**13.5 mm / 0.54"**

**Antiasit Krem**  
Antiacid Cream

# GRANİT KREM

Sırlı Porselen Karo / Glazed Porcelain Tile



**096901**  
**60x60 cm / 24" x 24"**  
**Krem / Cream**



**092201**  
**40x40 cm / 16"x16"**  
**Krem / Cream**



Ürün / Product	Ebat / Size (cm)	Birim / Unit (m <sup>2</sup> /Ad/kg)	Kutu / Box			Palet / Pallet		
			(Ad-Pcs)	(m <sup>2</sup> )	(kg)	(Kutu-Box)	(m <sup>2</sup> )	(kg)
Porselen Karo / Porcelain Tiles	60x60	m <sup>2</sup>	4	1,44	30	32	46,08	980
	40x40	m <sup>2</sup>	11	1,76	28,50	48	84,48	1,370
Teknik Porselen / Vitrified Porcelain	30x30	m <sup>2</sup>	6	0,54	15,6	60	32,4	1,010



# HAVUZ

Sırlı Porselen Karo / Glazed Porcelain Tile



**347910**  
30x60 cm / 12"x24"  
Aqua Mavi / Blue

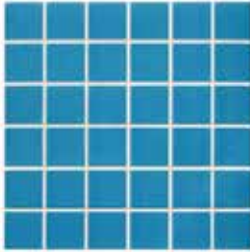

**343305**  
33x33 cm / 13"x13"  
Mozaik Koyu Mavi / Mozaik Dark Blue



**348102**  
12x24.5 cm / 4.9"x9.6"  
Parlak Lacivert / Glossy Navy Blue



**348101**  
12x24.5 cm / 4.9"x9.6"  
Parlak Mavi / Glossy Blue



**348103**  
12x24.5 cm / 4.9"x9.6"  
Beyaz / White



Ürün / Product	Ebat / Size (cm)	Birim / Unit (m <sup>2</sup> /Ad/kg)	Kutu / Box			Palet / Pallet		
			(Ad-Pcs)	(m <sup>2</sup> )	(kg)	(Kutu-Box)	(m <sup>2</sup> )	(kg)
Porselen Karo / Porcelain Tiles	30x60	m <sup>2</sup>	8	1,44	28	36	51,84	1,020
	33x33	m <sup>2</sup>	13	1,42	22,3	48	68,16	1,100
Duvar / Wall	12x24.5	m <sup>2</sup>	29	0,88	14,5	81	71,28	1,200





# RAL

Sırlı Porselen Karo / Glazed Porcelain Tile



**080202**  
20x20 cm / 8"x8" (m)  
RAL 0809005 **Krem / Cream**



**080201**  
20x20 cm / 8"x8" (m)  
RAL 9016 **Beyaz / White**



**080207**  
20x20 cm / 8"x8" (9)  
RAL 3000 **Kırmızı / Red**



**080206**  
20x20 cm / 8"x8" (m)  
RAL 0001500 **Siyah / Black**

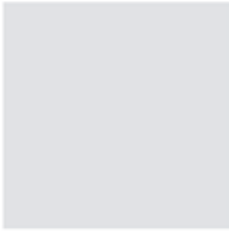

**080203**  
20x20 cm / 8"x8" (m)  
RAL 7047 **Açık Gri / Light Grey**



**080204**  
20x20 cm / 8"x8" (m)  
RAL 0005500  
**Koyu Gri / Dark Grey**



**080205**  
20x20 cm / 8"x8" (m)  
RAL 0007500 **Grej / Greige**

Ürün / Product	Ebat / Size (cm)	Birim / Unit (m <sup>2</sup> /Ad/kg)	Kutu / Box			Palet / Pallet		
			(Ad-Pcs)	(m <sup>2</sup> )	(kg)	(Kutu-Box)	(m <sup>2</sup> )	(kg)
Porselen Karo / Porcelain Tiles	20x20	m <sup>2</sup>	30	1,2	17,35	72	86,4	1250



# SERASTEP OUTDOOR

Porselen Karo / Porcelain Tile "UGL"



40x120 cm / 16"x48"  
2 cm Belgium Stone Outdoor Merdiven Basamağı Antrasit  
2 cm Belgium Stone Outdoor Step Antracite

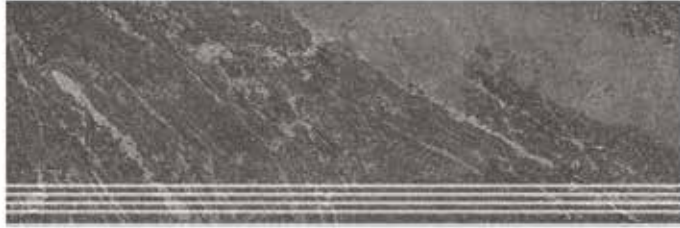

40x120 cm / 16"x48"  
2 cm Hardy Outdoor Merdiven Basamağı  
2 cm Hardy Outdoor Step



40x120 cm / 16"x48"  
2 cm Quarzite Outdoor Merdiven Basamağı  
2 cm Quarzite Outdoor Step



Ürün / Product	Kalınlık	Ebat / Size (cm)	Birim / Unit (m <sup>2</sup> /Ad/kg)	Kutu / Box (Ad-Pcs)	Kutu / Box (m <sup>2</sup> )	Adet - Pcs (kg)	Palet İçi Adet	Palet (m <sup>2</sup> )	Palet (kg)
Merdiven Basamağı	2 cm	40x120	m <sup>2</sup>	Kutusuz/Without Box		21,5	38	18,24	845



# SERASTEP OUTDOOR

Porselen Karo / Porcelain Tile "UGL"



40x120 cm / 16"x48"  
**2 cm Resolute Outdoor Merdiven Basamağı Gri**  
2 cm Resolute Outdoor Step Grey

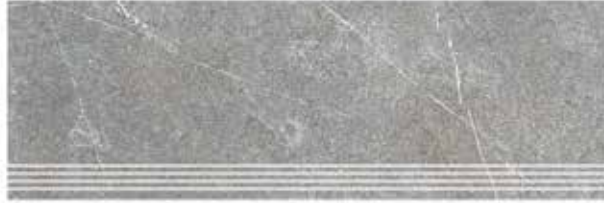

BB914701  
40x120 cm / 16"x48"  
**2 cm Resolute Outdoor Merdiven Basamağı Koyu Gri**  
2 cm Resolute Outdoor Step Dark Grey



40x120 cm / 16"x48"  
**2 cm Sagano Outdoor Merdiven Basamağı Gri**  
2 cm Sagano Outdoor Step Grey



BB904501 40x120 cm / 16"x48"  
**2 cm Sagano Outdoor Merdiven Basamağı Ceviz**  
2 cm Sagano Outdoor Step Noce



**SERASTEP**



# SERASTEP

Porselen Karo / Porcelain Tile "UGL"



**BB227901 30x120 cm / 12"x48"**  
**İstanbul Merdiven Basamağı Beyaz**  
Istanbul Step White



**BC228912 17,5x120 cm / 6,9"x48"**  
**İstanbul Beyaz Riht**  
Istanbul White Riht



**BA227901 8x120 cm / 3,2"x48"**  
**İstanbul Süpürgelik Beyaz / Istanbul Skirting White**



**BB227903 30x120 cm / 12"x48"**  
**İstanbul Merdiven Basamağı Açık Gri**  
Istanbul Step Light Grey



**BC228915 17,5x120 cm / 6,9"x48"**  
**İstanbul Açık Gri Riht**  
Istanbul Light Grey Riht



**BA227903 8x120 cm / 3,2"x48"**  
**İstanbul Süpürgelik Açık Gri**  
Istanbul Skirting Light Grey



**BB227904 30x120 cm / 12"x48"**  
**İstanbul Merdiven Basamağı Gri**  
Istanbul Step Grey



**BC228913 17,5x120 cm / 6,9"x48"**  
**İstanbul Gri Riht / Istanbul Grey Riht**



**BA227904 8x120 cm / 3,2"x48"**  
**İstanbul Süpürgelik Gri / Istanbul Skirting Grey**



**BB227902 30x120 cm / 12"x48"**  
**İstanbul Merdiven Basamağı Siyah**  
Istanbul Step Black



**BC228914 17,5x120 cm / 6,9"x48"**  
**İstanbul Siyah Riht / Istanbul Black Riht**



**BA227902 8x120 cm / 3,2"x48"**  
**İstanbul Süpürgelik Siyah / Istanbul Skirting Black**



# SERASTEP

Porselen Karo / Porcelain Tile "UGL"



**BB932904 30x120 cm / 12"x48"**  
**Milano Merdiven Basamağı Beyaz**  
Milano Step White



**BC933904 17,5x120 cm / 6,9"x48"**  
**Milano Beyaz Riht**  
Milano White Riht



**BA933904 8x120 cm / 3,2"x48"**  
**Milano Süpürgelik Beyaz / Milano Skirting White**



**BB932902 30x120 cm / 12"x48"**  
**Milano Merdiven Basamağı Bej**  
Milano Step Beige



**BC933902 17,5x120 cm / 6,9"x48"**  
**Milano Bej Riht**  
Milano Beige Riht



**BA933902 8x120 cm / 3,2"x48"**  
**Milano Süpürgelik Bej / Milano Skirting Beige**



**BB932901 30x120 cm / 12"x48"**  
**Milano Merdiven Basamağı Gri**  
Milano Step Grey



**BC933901 17,5x120 cm / 6,9"x48"**  
**Milano Gri Riht**  
Milano Grey Riht



**BA933901 8x120 cm / 3,2"x48"**  
**Milano Süpürgelik Gri / Milano Skirting Grey**



**BB932903 30x120 cm / 12"x48"**  
**Milano Merdiven Basamağı Siyah**  
Milano Step Black



**BC933903 17,5x120 cm / 6,9"x48"**  
**Milano Siyah Riht**  
Milano Black Riht



**BA933903 8x120 cm / 3,2"x48"**  
**Milano Süpürgelik Siyah / Milano Skirting Black**



**BB931912 30x120 cm / 12"x48"**  
**Venüs Merdiven Basamağı Beyaz**  
Venus Step White

**BC931902**  
**17,5x120 cm / 6,9"x48"**  
**Venüs Beyaz Riht / Venus Wihte Riht**

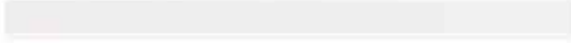

**8x120 cm / 3,2"x48"**  
**Venüs Süpürgelik Beyaz / Venus Skirting Wihte**



**BB931911 30x120 cm / 12"x48"**  
**Venüs Merdiven Basamağı Bej**  
Venus Step Beige

**BC931901**  
**17,5x120 cm / 6,9"x48"**  
**Venüs Bej Riht / Venus Beige Riht**



**8x120 cm / 3,2"x48"**  
**Venüs Süpürgelik Bej / Venus Skirting Beige**



**BB931913 30x120 cm / 12"x48"**  
**Venüs Merdiven Basamağı Dark Gri**  
Venus Step Dark Grey

**BC931903**  
**17,5x120 cm / 6,9"x48"**  
**Venüs Dark Gri Riht / Venus Dark Grey Riht**



**8x120 cm / 3,2"x48"**  
**Venüs Süpürgelik Dark Gri / Venus Skirting Dark Grey**



**BB931914 30x120 cm / 12"x48"**  
**BB931904 60x120 cm / 24"x48"**  
**Venüs Merdiven Basamağı Warm Gri**  
Venus Step Warm Grey

**BC933901 17,5x120 cm / 6,9"x48"**  
**Venüs Warm Gri Riht**  
Venus Warm Grey Riht



**8x120 cm / 3,2"x48"**  
**Venüs Süpürgelik Warm Gri / Venus Skirting Warm Grey**



**BB931915 30x120 cm / 12"x48"**  
**Venüs Merdiven Basamağı Siyah**  
Venus Step Black

**BC931905**  
**17,5x120 cm / 6,9"x48"**  
**Venüs Siyah Riht / Venus Black Riht**



**8x120 cm / 3,2"x48"**  
**Venüs Süpürgelik Siyah / Venus Skirting Black**



# SERASTEP

Porselen Karo / Porcelain Tile "UGL"



**BB934901 30x120 cm / 12"x48"**  
**Black Marble Merdiven Basamağı / Black Marble Step**



**BA934901 8x120 cm / 4"x48"**  
**Black Marble Süpürgelik / Black Marble Skirting**

Ev içi kullanıma uygundur. / Suitable for residential usage.



**BB934920 30x120 cm / 12"x48"**  
**Nat. Black Marble Merdiven Basamağı**  
Nat. Black Marble Step



**BC934920 17,5x120 cm / 6,9"x48"**  
**Nat. Black Marble Riht / Nat. Black Marble Riht**



**BA934920 8x120 cm / 4"x48"**  
**Nat. Black Marble Süpürgelik / Nat. Black Marble Skirting**

Ev içi kullanıma uygundur. / Suitable for residential usage.

Ürün / Product	Ebat / Size (cm)	Birim / Unit (m <sup>2</sup> /Ad/kg)	Kutu / Box			Palet / Pallet		
			(Ad-Pcs)	(m <sup>2</sup> )	(kg)	(Kutu-Box)	(m <sup>2</sup> )	(kg)
Merdiven Basamağı	30x120	m <sup>2</sup>	3	1,08	26	26	28,08	690
Süpürgelik / Skirting	8x120	m <sup>2</sup>	4	0,384	9,6	70	26,88	687
Riht	17,5x120	m <sup>2</sup>	4	0,816	20,25	46	37,53	946





**BB905401 30x120 cm / 12"x48"**  
**Monte Verde Gri Merdiven Basamađı**  
Monte Verde Grey Step



**BC905401 17,5x120 cm / 6,9"x48"**  
**Monte Verde Gri Riht / Monte Verde Grey Riht**

**BA905401 8x120 cm / 4"x48"**  
**Monte Verde Gri Sprgelik**  
Monte Verde Grey Skirting



**BB905402 30x120 cm / 12"x48"**  
**Monte Verde Zeytin Merdiven Basamađı**  
Monte Verde Olive Step



**BC905421 17,5x120 cm / 6,9"x48"**  
**Monte Verde Zeytin Riht**  
Monte Verde Olive Riht

**BA905402 8x120 cm / 4"x48"**  
**Monte Verde Zeytin Sprgelik**  
Monte Verde Olive Skirting



**BB905400 30x120 cm / 12"x48"**  
**Monte Verde Mix Merdiven Basamađı**  
Monte Verde Mix Step



**BC905900**  
**17,5x120 cm / 6,9"x48"**  
**Monte Verde Mix Riht / Monte Mix Riht**

**BA905400 8x120 cm / 4"x48"**  
**Monte Verde Mix Sprgelik**  
Monte Verde Mix Skirting



**BB905403 30x120 cm / 12"x48"**  
**Monte Verde Maun Merdiven Basamađı**  
Monte Verde Maun Step



**BC905431 17,5x120 cm / 6,9"x48"**  
**Monte Verde Maun Riht**  
Monte Verde Maun Riht

**BA905403 8x120 cm / 4"x48"**  
**Monte Verde Maun Sprgelik**  
Monte Verde Maun Skirting



# SERASTEP

Porselen Karo / Porcelain Tile "UGL"



**BB904401 30x120 cm / 12"x48"**  
**Sagano Gri Merdiven Basamağı**  
Sagano Grey Step



**BC904952 17,5x120 cm / 6,9"x48"**  
**Sagano Gri Riht**  
Sagano Grey Riht



**BB904402 30x120 cm / 12"x48"**  
**Sagano Badem Merdiven Basamağı**  
Sagano Almond Step



**BC904904 17,5x120 cm / 6,9"x48"**  
**Sagano Badem Riht**  
Sagano Almond Riht



**BB904403 30x120 cm / 12"x48"**  
**Sagano Ceviz Merdiven Basamağı**  
Sagano Noce Step



**BC904956 17,5x120 cm / 6,9"x48"**  
**Sagano Ceviz Riht**  
Sagano Noce Riht

**BA904403 8x120 cm / 4"x48"**  
**Sagano Ceviz Süpürgelik /**  
Sagano Noce Skirting



**BB904404 30x120 cm / 12"x48"**  
**Sagano Oak Merdiven Basamađı /**  
 Sagano Oak Step

**BC904901 17,5x120 cm / 6,9"x48"**  
**Sagano Oak Riht**  
 Sagano Oak Riht



**BA904404 8x120 cm / 4"x48"**  
**Sagano Oak Süpürgelik /**  
 Sagano Oak Skirting



**BB904405 30x120 cm / 12"x48"**  
**Sagano Kestane Merdiven Basamađı /**  
 Sagano Chestnut Step

**BC904955 17,5x120 cm / 6,9"x48"**  
**Sagano Kestane Riht**  
 Sagano Chestnut Riht



**BA904400 8x120 cm / 4"x48"**  
**Sagano Kestane Süpürgelik /**  
 Sagano Chestnut Skirting



**BB903400 30x120 cm / 12"x48"**  
**Daintree Beyaz Merdiven Basamađı /**  
 Daintree White Step

**17,5x120 cm / 6,9"x48"**  
**Daintree Beyaz Riht**  
 Daintree White Riht



**BA903400 8x120 cm / 4"x48"**  
**Daintree Beyaz Süpürgelik /**  
 Daintree White Skirting

Ürün / Product	Ebat / Size (cm)	Birim / Unit (m <sup>2</sup> /Ad/kg)	Kutu / Box			Palet / Pallet		
			(Ad-Pcs)	(m <sup>2</sup> )	(kg)	(Kutu-Box)	(m <sup>2</sup> )	(kg)
Merdiven Basamađı	30x120	m <sup>2</sup>	3	1,08	26	26	28,08	690
Süpürgelik / Skirting	8x120	m <sup>2</sup>	4	0,384	9,6	70	26,88	687
Riht	17,5x120	m <sup>2</sup>	4	0,816	20,25	46	37,53	946



# TEKNİK BİLGİLER VE ÖZELLİKLER

TECHNICAL INFORMATION &  
CHARACTERISTICS



Yükseltilmiş Zemin Uygulaması / Elevated Floor Application

## Uygulamada Pratik, Hızlı ve Yenilikçi Çözümler;

Park, bahçe, veranda, sahil ve plaj gibi alanlarda; yapıştırıcı, derz ve döşeme işçiliği gerektirmeden direkt çim, çakıl ve kum üzerine hızlı ve pratik şekilde uygulanabilen, uygulamada yenilikçi çözümler getiren porselen karolar; gerektiğinde sökülüp başka bir mekana yeniden takılabilen, yükseltilmiş zemin döşemelerine uygun olarak üretilmiştir.

2 cm porselen karolar, geleneksel seramik yapıştırıcı uygulaması ile yoğun yaya trafiği ve ağır yük dayanımı gerektiren alanlarda güvenle kullanılabilir. Seramik yapıştırıcısı ile yapılan bu uygulama kırılmaya ve çatlama karşı yüksek dayanım sağlayarak yoğun trafiğin ve aşınmanın olduğu zeminlerde profesyonel çözümler sunuyor.

## Practical, Fast and Innovative Solutions in Application;

Porcelain tiles, bringing innovative solutions to the direct application of grass, gravel, and sand quickly and practically without requiring adhesive, joint and floor workmanship in areas such as park, garden, patio, seaside, and beach, are manufactured in line with raised flooring, which can be disassembled and re-assembled to another space if necessary.

2 cm porcelain tiles can be used safely with traditional adhesives for ceramic bonding applications in areas requiring intense pedestrian traffic and heavy load resistance. This application, which is made with ceramic adhesive, provides high strength against breaking and cracking and offers professional solutions on floors exposed to intense traffic and corrosion.



**Çimen Üzerine Uygulama** / Application on Grass



**Seramik Yapıştırıcısıyla Uygulama** / Application with Ceramic Adhesive



**Çakıl Taşı Üzerine Uygulama** / Application on Gravel



**Kum Üzerine Uygulama** / Application on Sand



# TEKNİK BİLGİLER VE ÖZELLİKLER / TECHNICAL INFORMATION & CHARACTERISTICS

## Semboller / Symbols



**Yer Karosu**  
Floor Tile



**Duvar Karosu**  
Wall Tile



**Tek Pişirim**  
Single Firing



**Çift Pişirim**  
Double Firing



**Üç Pişirim**  
Third Firing



**Parlak**  
Glossy



**Mat**  
Matt



**Full**  
Lappato



**High**  
Glossy



**Naturel**  
Natural



**Semi**  
Lappato



**Nanotech**



**Renk Tonu Değişim**  
Color Shade Variation



**Kaymazlık**  
Slipping Rate



**Aşınmaya Dayanıklılık**  
Abrasion Resistance



**Renkli Masse**  
Color Body



**Full Body**



**Rektifiyesiz**  
Unrectified



**Rektifiyeli**  
Rectified



**İç Mekan**  
Indoor



**Dış Mekan**  
Outdoor



**Dış Cephe**  
Facade



**Ticari Alanlar**  
Commercial Areas



**Kalınlık**  
Thickness



**Endüstriyel Zeminler**  
Industrial Fields



**Sugar Efekt**  
Sugar Effect





## Porselen Karo Teknik Özellikleri / Porcelain Tiles Technical Characteristics

Teknik Özellikler / Technical Characteristics	Türk & Avrupa Standardı Turkish & European Standard (TS - EN 14411 Bla)	Seramiksan Sırlı & Sırsız Porselen Karolar Glazed & Unglazed Porcelain Tiles	TS - EN
<b>Ebat Toleransı Uzunluk ve Genişlik</b> Deviations from Dimensions Length and Width (L=cm, S=cm <sup>2</sup> )	N (Nominal Size) ≥ 15 cm = ± % 0,6, ± 2 mm	N (Nominal Size) ≥ 15 cm = ± % 0,6, ± 2 mm	ISO 10545 - 2
<b>Ebat Toleransı Kalınlık</b> / Deviations from Dimensions Thickness (%)	± % 5, ± 0,5 mm	± % 5, ± 0,5 mm	ISO 10545 - 2
<b>Gönyeden Sapma</b> / Rectangularity	% 0,5, ± 2 mm	± % 0,4, ± 2 mm	ISO 10545 - 2
<b>Kenar Düzgünlüğü</b> / Straightness of Sides	± % 0,5, ± 1,5 mm	± % 0,3, ± 1,5 mm	ISO 10545 - 2
<b>Yüzey Kalitesi</b> / Surface Quality	Max. % 5 Kusurlu / % 5 Defective	Uygundur / Affirmative	ISO 10545 - 2
<b>Düzlemden Sapma</b> / Surface Flatness	% 0,5	% 0,3	ISO 10545 - 2
<b>Su Emme Sırlı Porselen</b> / Water Absorption Glazed Porcelain Tile	Max. % 0,5	Max. % 0,5	ISO 10545 - 3
<b>Su Emme Sırsız Porselen</b> / Water Absorption Unglazed Porcelain Tile	Max. % 0,5	Max. % 0,05	ISO 10545 - 3
<b>Eğilme Dayanımı Sırlı Porselen</b> Bending Strength Glazed Porcelain Tiles (N/mm <sup>2</sup> )	35	40	ISO 10545 - 4
<b>Eğilme Dayanımı Sırsız Porselen</b> Bending Strength Unglazed Porcelain Tiles (N/mm <sup>2</sup> )	35	45	ISO 10545 - 4
<b>Aşınmaya Dayanıklılık Sırlı Porselen</b> Abrasion Resistance Glazed Porcelain Tiles	Üretici beyan eder. Abrasion class and cycles passed.	Katalog içerisinde beyan edilmiştir. Indicated in the catalogue.	ISO 10545 - 7
<b>Aşınmaya Dayanıklılık Sırsız Porselen</b> Abrasion Resistance Unglazed Porcelain Tiles	Max. 175 mm <sup>3</sup>	Max. 175 mm <sup>3</sup>	ISO 10545 - 7
<b>Isıl Genleşme Katsayısı</b> / Linear Thermal Expansion Coefficient	Üretici beyan eder. Declared value.	< 90x10 <sup>-7</sup> K <sup>-1</sup>	ISO 10545 - 8
<b>Isı Şokuna Dayanıklılık</b> / Resistance to Thermal Shock	İstenir / Required	Uygundur / Affirmative	ISO 10545 - 9
<b>Çatlama Dayanımı</b> / Cracking Resistance Tiles	İstenir / Required	Uygundur / Affirmative	ISO 10545 - 11
<b>"Asit ve Alkaliye Dayanıklılık</b> / Resistance to Acids and Alkalies"	Üretici beyan eder. Declared value.	Uygundur / Affirmative	ISO 10545 - 13
<b>"Eysel Temizlik Maddelerine ve Yüzme Havuzu Tuzlarına Dayanıklılık Sırlı Karolar</b> Resistance to Household Chemicals and Swimming Pool Salts Glazed Tiles"	Min. GB	Min. GB	ISO 10545 - 13
<b>"Eysel Temizlik Maddelerine ve Yüzme Havuzu Tuzlarına Dayanıklılık Sırsız Karolar</b> Resistance to Household Chemicals and Swimming Pool Salts Unglazed Tiles"	Min. UB	Min. UB	ISO 10545 - 13
<b>Lekelenmeye Dayanıklılık</b> / Resistance to Staining	Min. Sınıf 3 / Min. Class 3	Min. Sınıf 3 / Min. Class 3	ISO 10545 - 14

Tablolarda belirtilen toplam palet ağırlıkları, üretim teknolojisi, kullanılan ambalaj malzemeleri ve paletlemeden kaynaklanan değişikliklerden dolayı farklılıklar arz edebilir.

\* Teknik porselenlerde su emme <%0,05 ve aşınma değeri <175 mm<sup>3</sup>

Seramiklerin yanında görülen numaralar, Türk ve Avrupa Standardı TS-EN 10545-7'ye göre yüzey aşınma dayanım sınıfını belirler.

The numbers beside ceramic tiles indicate the abrasion resistance of the ceramic surface according to Turkish and European Standard TS-EN 10545-7

Seramiksan, bu katalogta belirtilen ve hiç biri yasal olarak bağlayıcı olmayan bilgi ve teknik özellikleri, dilediği herhangi bir anda ve önceden haber vermeden değiştirme hakkını saklı tutar. Ağırlık, renk ve boyutlar, seramik fırınlarına işleminden kaynaklanan normal sınırlar içinde değişiklik gösterebilir. Katalogumuzda belirtilen renkler ürünlerimizin gerçek renklerini yansıtmayabilir.

Seramiksan, reserves the right at any time and without prior notice to change the information and technical characteristics given in this catalog, none of which are to be considered legally binding. Weights, colors and dimensions are subjects to the normal variations resulting from the ceramic firing process. The colors that are seen in our catalog may not reflect the original colours of our products.



## Temizlik ve Bakım Talimatı

Döşeme sonrası, seramik yüzeydeki derz kalıntılarını kurumadan mutlaka temizlenmelidir, yüzeyde sertleşmesine izin verilmemelidir. Bu işlem için sadece su ve temiz bir sünger yeterlidir.

Derz dolgu kalıntılarının, seramik yüzeylerde kuruyarak sertleşmesi temizliği güçleştirir. Bu durumda karo yüzeyleri ancak özel kimyasallarla temizlenebilir bu özel kimyasalların içeriği ve kullanım yöntemi üreticisi tarafından belirlenir. Temizlik sonrası yüzeyler birkaç kez su ile durulanmalıdır.

Kimyasala karşı hassas karoların (örneğin metalik yüzeyler gibi) temizliğinde sadece su ve nötr olarak adlandırılan temizlik malzemeleri kullanılmalıdır (asidik yada bazik temizlik malzemeleri yüzeyde hasara neden olabilir).

Döşeme yerine göre, karonun döşendiği yerdeki kirlenme potansiyeline ve karonun yüzey spesifikasyonuna göre temizlik sıklığı haftalık, günlük veya günde birkaç kez şeklinde değişebilir.

Sırlı (özellikle parlak yüzeyli yer ve duvar karoları) karolarda yüzeylerin çizilmesi riskine karşı, toz içeren temizlik malzemeleri yerine jel yada krem temizleyiciler kullanılmalıdır.

Büyük alanlardaki karolar döner, silindirik fırçalı makineler ile fırçanın hızı uygun hıza ayarlanmak sureti ile temizlenebilir, temizlik esnasında deterjan kullanılacak ise sonrasında temiz su ile durulanması unutulmamalıdır.

Hydroflorik asit gibi güçlü kimyasal içeren temizlik maddeleri seramik yüzeyinin matlaşmasına neden olacağı için kullanılmamalıdır. Aşındırıcı mekanik temizlik uygulamaları ile kullanılan kimyasallar karonun yüzey spesifikasyonlarına zarar vereceğinden dolayı kullanılmamalıdır.

## Cleaning and Maintenance Instruction

After tiling, joint remains should be cleaned before they dry on the ceramic surface; they should not be let to be hardened on the surface. Only water and a clean sponge are enough for this process.

Joint filling remains get hardened on the ceramic surface and make the cleaning process to be difficult. In this case, the tile surfaces can be cleaned only by special chemicals. The content and usage methods of these special chemicals are specified by the manufacturer. Surfaces should be rinsed by water for a few times after the cleaning.

During the cleaning of the tiles which are sensitive to chemicals (for example, the metallic surfaces), only water and cleaning materials called as neutral should be used. Acidic or basic cleaning materials can cause damage on the surface.

According to the tiling place, fouling potential and surface characteristic of the tile, cleaning frequency can vary as weekly, daily or a few times during a day.

Against the risk of scratch on the surfaces of glazed tiles (especially floor or wall tiles which have shining tiles), gel or cream cleaners should be used instead of cleaning materials consisting dust.

Tiles in the big areas can be cleaned by machines with rotary cylindrical brushes by setting the speed of the brush appropriate for the tiles. If detergent is used during the cleaning, it should not be forgotten to be rinsed by clean water.

Cleaning materials including strong chemicals such as hydrofluoric acid should not be used because they can cause surfaces of the tiles to become opaque. Chemicals used with abrasive mechanic cleaning applications should not be used because they will harm to the surface characteristics of the tile.



## Su Emme Değerleri Açıklaması / Water Absorption

### Karo Seramik Sınıflandırması - EN 14411 / Tile Ceramic Classification - En 14411

SU EMME (E) / Water Absorption (E)				
<b>Grup Ia</b> 0% < E ≤ 0,5%	<b>Grup Ib</b> 0,5% < E < 3%	<b>Grup IIa</b> 3% < E < 6%	<b>Grup IIb</b> 6% < E < 10%	<b>Grup III</b> E > 10%
Grup Ala	Grup Alb	Grup Alla-1 Grup Alla-2	Grup Allb-1 Grup Allb-2	Grup Alll
Grup Bla	Grup Blb	Grup Blla	Grup Bllb	Grup Blll

**Duvar Karosu (bkz: ilgili Tablo) / Wall Tile (see: Related Table)**

**Kuru preslenmiş seramik karolar TS EN 14411, Grup BIII, su emme (Eb > 10%), GL**  
Dry-pressed ceramic tiles TS EN 14411, Group BIII, Water Absorption (Eb > 10%) , GL

**Yer Karosu (bkz: ilgili Tablo) / Floor Tile (see: Related Table)**

**Kuru preslenmiş seramik karolar TS EN 14411, Grup BIb, su emme (0,5% < Eb < 3%) , GL**  
Dry-pressed ceramic tiles TS EN 14411, Group BIb, Water Absorption (0,5% < Eb < 3%) , GL

**Sırlı Porselen (bkz: ilgili Tablo) / Glazed Porcelain (see: Related Table)**

**Kuru preslenmiş seramik karolar TS EN 14411, Grup BIa,, su emme (Eb < 0,5%) , GL**  
Dry-pressed ceramic tiles TS EN 14411, Group BIa,, Water Absorption (Eb < 0,5%) , GL

**Porselen / Granit (bkz: ilgili Tablo) / Porcelain / Granite (see: Related Table)**

**Kuru preslenmiş seramik karolar TS EN 14411, Grup BIa,, su emme (Eb < 0,5%) , UGL (sırsız)**  
Dry-pressed ceramic tiles TS EN 14411, Group BIa,, Water Absorption (Eb < 0,5%) , UGL (unglazed)

**Teknik Granit / Technical Granite**

**Su emme değeri < 0,05%**  
Water Absorption value < 0,05%



## Kaydırmazlık Sınıfı / Anti-Slip Resistance



## Antislip Seriler / Antislip Series

SERİ ADI SERIE	AÇIKLAMA PRODUCT	EBAT SIZE	R DEĞERİ VALUE R
RESOLUTE	OUTDOOR	120*120 / 40*120 / 60*60	R12
QUARZITE	OUTDOOR	120*120 / 40*120 / 60*60	R12
HARDY	OUTDOOR	120*120 / 40*120 / 60*60	R13
BELGIUM STONE	OUTDOOR	120*120 / 40*120 / 60*60	R12
SAGANO	OUTDOOR	40*120	R12
CEMENT		60*120 / 60*60	R9
URBAN		60*120 / 60*60	R9
URBAN	ANTISLIP	60*120 / 60*60	R11



## Yüzey Bitişi / Surface Treatments

### High Glossy

**Porselen karoların özel bir sır ile kaplanması ile elde edilen yüksek parlaklıktaki ürünlerdir.**  
They are highly lustrous porcelain tiles covered with a special glaze.

### Mat / Matt

**Yüzeyleri mat dokulu sır ile kaplanmış, yüzeyi işlem görmemiş karolardır.**  
They are natural tiles whose surfaces are glazed with matt glaze.

### Parlak / Glossy

**Yüzeyleri parlak dokulu sır ile kaplanmış, yüzeyi işlem görmemiş karolardır.**  
They are natural tiles whose surfaces are glazed with glossy glaze.

### Lappato / Semi polished

**Özel cam taneçikleri ile kaplanıp pıdırılmış karoların parlatılması ile elde edilen yarı parlak yarı mat yüzeylerdir.**  
They are semi-polished surfaces manufactured via the lustering of tiles after covering them with special glass grains/glass forming minerals then firing them.

### Rölyef / Relief

**Karoların şekillendirilmesi sırasında kalıplar vasıtası ile elde edilen yüzey dokularıdır.**  
They are the surface textures which are produced by moulds at the time of tile-sculpting.

### Full Lappato

**Özel sır ile kaplanmış karoların ince bir parlatma işlemine tabi tutulması ile elde edilen karolardır.**  
They are type of tiles produced by fine polishing of tiles covered with a special glaze.

## Aşınmaya Dayanıklılık / Abrasion Resistance

**P.E.I. - 1 Duvarlar ile banyo ve yatak odası zeminleri için uygundur.** / Suitable for walls, bathroom and bedroom floors.

**P.E.I. - 2 Konutlar gibi yaya trafiği az olan zeminler için uygundur.** / Suitable for light traffic environments like the floor of a house.

**P.E.I. - 3 Antre, koridor gibi giriş çıkışı fazla olan zeminler için uygundur.** / Suitable for moderately heavy traffic area floors, like the entrance and the corridor.

**P.E.I. - 4 Mağaza, restoran gibi yaya trafiğine daha fazla maruz kalan zeminler için uygundur.** / Suitable for heavy traffic area floors like restaurants, shopping stores, etc.

**P.E.I. - 5 Mağaza, otel, restoran, ofis, okul, teşhir salonu gibi yaya trafiğine fazla maruz kalan zeminler için uygundur.** / Suitable for floors subject to heavy foot traffic and abrasion, such as shops, hotels, restaurants, offices, schools, exhibition halls, etc.

## Renk Tonu Değişim Skalası / Color Shade Variation Guide

<b>V1 DÜŞÜK</b> UNIFORM	<b>Desen ve renk tonu farklılıkları düşük seviyededir.</b> The least amount of shade and texture variation attainable in naturally fired clay products.
<b>V2 ORTA</b> SLIGHT	<b>Desen ve renk tonu farklılıkları orta seviyededir.</b> Light to moderate shade and texture variation within each box.
<b>V3 YÜKSEK</b> HIGH	<b>Desen ve renk tonu farklılıkları yüksek seviyededir.</b> High shade and texture variation within each box.
<b>V4 DEĞİŞKEN</b> RANDOM	<b>Desen ve renk tonu farklılıkları en üst seviyededir.</b> Very high shade and texture variation within each box.

## Kenar Bitişi / Edge Treatments

### Rektifiyeli (Ebatlanmış) / Rectified

**Karoların kenarlarının traşlanarak 1mm'den daha düşük sapma olacak şekilde aynı boyuta (tek kalibrasyona) getirilmesi işlemidir. Bu sayede ürünler daha küçük derz aralıkları ile döşenebilir ve görsel kalite artar.**

It is the process of cutting the edges of tiles to same size with the deviation of less than 1 mm. As a result, these tiles can be laid with a narrower grout joint. Moreover, visual quality increases.

### Pahlı / Chamfered

**Karoların ebatlamadan sonra kenarlarındaki keskinliğin yuvarlatılması işlemidir. Bu sayede kullanıcıya verebileceği zarar engellenmiş olur. Aynı zamanda kenar kırılmaları da önlenir.**

The process of rounding of the edges of tiles after the tile sizing. This process prevents damage to the user. At the same time it prevents edge breaks.



## Asit ve Alkaliye Dayanıklılık / Resistance to Acid and Alkali

### SIRLI / GLAZED :

**SIRLI KAROLARDA YÜKSEK ÇÖZELTİ SINIFI B'dir. Tablo da minimum GHB girilebilir.**

HIGH SOLUTION CLASS FOR GLAZED TILES IS B. Minimum GHB can be written in the table.

**SIRLI KAROLARDA DÜŞÜK ÇÖZELTİ SINIFI B'dir. Tablo da minimum GLB girilebilir.**

LOW SOLUTION CLASS FOR GLAZED TILES IS B. Minimum GLB can be written in the table.

**GHB/GLB: Kesilmiş kenarlarda görülebilir değişiklik var.**

GHB/GLB : There is an obvious change in the corners which have been cut.

### SIRSIZ / UNGLAZED :

**SIRSIZ KAROLARDA YÜKSEK ÇÖZELTİ SINIFI B'dir. Tablo da minimum UHB girilebilir.**

HIGH SOLUTION CLASS FOR UNGLAZED TILES IS B. Minimum UHB can be written in the table.

**SIRSIZ KAROLARDA DÜŞÜK ÇÖZELTİ SINIFI B'dir. Tablo da minimum ULB girilebilir.**

LOW SOLUTION CLASS FOR UNGLAZED TILES IS B. Minimum ULB can be written in the table.

**UHB/ULB : Kesilmiş kenarlarda görülebilir değişiklik var**

UHB/ULB : There is an obvious change in the corners which have been cut.

## Eysel Temizlik Maddelerine ve Yüzme Havuzu tuzlarına dayanıklılık; Resistance to Domestic Cleaning Materials and Swimming Pool Salts

**Sınıf 5; / Class 5;**

• **Lekelenmiş deney numunesi akan sıcak su altında 5 dakika yıkanır, yüzeyi temiz nemli bir bez ile silinir eğer leke çıkarsa sınıf 5.**

Stained experience sample is washed under flowing hot water for 5 minutes, and its surface is wiped by a clean wet fabric; so if the stain is removed, then the class is 5.

**Sınıf 4; / Class 4;**

• **Numune zayıf temizleme maddesi ile silinir, yüzey akar su ile temizlenir eğer leke çıkarsa sınıf 4.**

Sample is wiped by a weak cleaning material, and the surface is cleaned by a flowing water; so if the stain is removed, then the class is 4.

**Sınıf 3; / Class 3;**

• **Numune güçlü temizleme malzemesi ile mekanik olarak temizlenir. Eğer leke çıkar ise sınıf 3.**

Sample is cleaned mechanically by a strong cleaning material; so if the stain is removed, then the class is 4.

**Sınıf 2 / Class 2;**

• **Numune uygun bir çözücü içine daldırılarak 24 saat bekletilir, yüzeyi akar su altında iyice durulanır ve sonra nemli bir bezle silinir.**

• Sample is waited within a dissolvent and its surface is rinsed under a flowing water properly, then it is wiped by a clean wet fabric.

• **Çözücülerden herhangi biri lekeyi çıkartırsa, temizleme tamamlanmış kabul edilir.**

• If one of the dissolvent removes the stain, cleaning is considered to be done.



## PAKETLEME DETAYLARI / PACKAGING DETAILS

### Porselen Karolar / Porcelain Tiles

Ebat Size	Adet/Kutu Pcs/Box	m <sup>2</sup> /Kutu Sqm/Box	Kutu/Palet Box/Pal.	m <sup>2</sup> /Palet Sqm/Pal.	Kg (Brüt)/Palet Kgs (Gross)/Pal.
60x120 24"x48" S.Por. / G. Por. (Flap.)	2	1,44	29	41,76	1.080
30x120 12"x48" S.Por. / G. Por.	3	1,08	40	43,20	1.050
20x120 8"x48" S.Por. / G. Por.	4	0,96	36	34,56	851
60x60 24"x24" S.Por. / G. Por. (Flap.)	4	1,44	30	43,20	1.140
120x120 48"x48" Por	1	1,44	30	43,2	1.100
30x30 12"x12"	6	0,54	60	32,4	1000

### Serastep / Outdoor Serastep (2 cm)

Ebat Size	Adet/Kutu Pcs/Box	m <sup>2</sup> /Kutu Sqm/Box	Kutu/Palet Box/Pal.	m <sup>2</sup> /Palet Sqm/Pal.	Kg (Brüt)/Palet Kgs (Gross)/Pal.
60x120 Serastep 24"x48"	2	1,44	-	-	-
30x120 Serastep 12"x48"	3	1,08	40	43,20	1.050
17,5x120 Serastep Riht 6,9"x48"	4	0,816	46	37,53	946
8x120 Serastep 4"x48"	4	0,384	70	26,88	687
40x120 Outdoor Serastep (2 cm) 16"x48"	Kutusuz / Without Box		38	18,24	845

### Outdoor (2 cm)

Ebat Size	Adet Kg Pcs/Kgs	Palet İçi Karo Adet Pcs/Pal.	Palet m <sup>2</sup> Pal./Sqm	Palet kg Pal./Kgs
120x120 (2 cm) 48"x48"	60,20	15	21,60	951,00
60x60 (2 cm) 24"x24"	16,60	60	21,60	1.022,00
40x120 (2 cm) 16"x48"	21,50	38	18,24	845,50





# Yapı Kimyasalları

## Construction Chemicals





### **CERAFIX**

Çimento Esaslı Seramik ve Fayans Yapıştırma Harcı

111-113

---

### **CERAFIX**

Çimento Esaslı Granit Yapıştırma Harcı

114-116

---

### **CERABOND**

Çimento Esaslı Granit Yapıştırma Harcı

117-119

---

### **CERAFLEX**

Granit ve Seramik için Esnek Yapıştırma Harcı

120-122

---

### **CERAFILL**

Silikonlu, Renkli Derz Dolgu (1 - 6 mm)

123-125

---

Seramik uygulaması ipuçları

126-127

---

# CERAFIX

Çimento Esaslı Seramik ve Fayans Yapıştırma Harcı  
*Superadhesive Mortar For Wall & Ceramic Tiles*



## Tanımı

Çimento esaslı, kayma özelliği azaltılmış, seramik, fayans ve mermer yapıştırma harcı.

## Uygulama Alanları

- Beton, sıva ve şap gibi yüzeylerde,
- Banyo, mutfak ve koridor gibi yerlerde; yatay ve düşey uygulamalarda, küçük ve orta duvar seramikleri, dekoratif tuğla, mermer, traverten, doğal taş gibi kaplama malzemesinin yapıştırılmasında.

## Özellikleri

- Hazırlanması ve uygulanması kolay, ekonomik bir yapıştırıcıdır.
- Kolay taraklanır ve işleme süresi uzundur.
- Yüksek yapışma özelliği ile düşey uygulamalarda kayma yapmaz.

## Teknik Özellikleri

(23 °C ve % 50 Bağıl nem)

<b>Görünüm</b>	:	Gri renkli toz
<b>Raf Ömrü</b>	:	Kapalı ambalajında ve rutubetsiz ortamda 12 ay
<b>Uygulama Sıcaklığı</b>	:	(+5 °C) - (+35°C)
<b>Karışım Oranı</b>	:	6,5 - 7L su / 25 Kg
<b>Tüketim</b>	:	3-6 Kg/m <sup>2</sup>
<b>Olgunlaştırma süresi</b>	:	5 dk.
<b>Kap Ömrü</b>	:	2 saat
<b>Kullanıma alma süresi</b>	:	24 saat sonra
<b>Derz Dolgu Süresi</b>	:	24 saat sonra
<b>Sıcaklık Dayanımı</b>	:	(-20 °C) - (+ 80°C)
<b>Uygulama Kalınlığı</b>	:	3 - 10 mm
<b>Açık Bekletme Süresi</b>	:	(EN 1346) ≥ 0,5 N/mm <sup>2</sup> (20 dk. Sonra)
<b>Başlangıç Yapışma</b>	:	(EN 1348) ≥ 0,5 N/mm <sup>2</sup> (28 gün)
<b>Suya Daldırma sonrası</b>	:	(EN 1348) ≥ 0,5 N/mm <sup>2</sup>
<b>Isıyla Yaşlandırma sonrası</b>	:	(EN 1348) ≥ 0,5 N/mm <sup>2</sup>
<b>Donma Çözünme sonrası</b>	:	(EN 1348) ≥ 0,5 N/mm <sup>2</sup>

## Ambalaj

25 Kg Kraft torba

TS EN 12004 - C1 sınıfının öngördüğü normlara uygundur.

C = Çimento esaslı

1 = Normal sertleşen

# UYGULAMA TALİMATLARI

## Yüzey Hazırlığı

- Uygulama yapılacak yüzey kürünü almış terazisinde, düzgün ve sağlam olmalı,
- Yüzeyde yapışma performansını olumsuz etkileyecek, gevşek parçacıklar, yağ, toz, kir, parafin vs. gibi kalıntılar olmamalı,
- Gevşek yerler kırılarak temizlenmeli ve yüzeydeki boşluklar uygun bir tamir harcı ile tamir edilerek düzeltilmeli ve kürenmesi beklenmelidir.
- Yüzeyin su emiciliği yüksek ise veya sıcaklık 25 °C üzerindeyse yüzey nemlendirilmelidir.



Yüzeyin düzgünlüğünün kontrol edilmesi



Yüzeyin temizlenip nemlendirilmesi

## Karıştırma

- Uygun su miktarı (6,5 Lt) bir karıştırma kabı içerisine ölçer vasıtasıyla alınır,
- Düşük devirli (400-500 dev/dk.) bir karıştırıcı ile karıştırma yapılırken 25 Kg CERAFIX harcı yavaş yavaş su üzerine ilave edilir.
- Topaksız ve homojen bir karışım elde edinceye kadar birkaç dakika karıştırılır. (Harç içerisine uygulama talimatında belirtilmeyen herhangi bir katkı eklemeyiniz.)
- 5 dakika dinlenmeye bırakılır.
- Uygulamaya başlamadan önce 1-2 dk. daha karıştırıldıktan sonra harç kullanıma hazır hale gelir.



Harcın suya eklenmesi



Karıştırıcı ile karıştırma



Homojen karışım

## Uygulama Yöntemi

- Hazırlanan harç malanın düz kısmı ile uygulama yüzeyine yayılır. Daha sonra kullanılacak karoların boyutuna uygun olarak seçilen tarak ile taraklanır.
- Harcın açık bekletme süresi içerisinde (maximum 30 dk.) kaplanabilecek kadar bir alana çekilmesine dikkat edilmelidir.

- Tarakla çekme işlemi tek yönde ve eşdeğer formda olmalıdır. Isı değişimleri veya yoğun yaya ve yük trafiğinin olduğu yerlerde geniş ebatlı karolar için karonun arkasına yaklaşık 1mm kalınlığında düzgün olarak harç sürülmesi önerilir. Bu yöntem yüzeydeki seviye farklılıklarından kaynaklanacak hataları önleme ve daha iyi bir yapışma performansı elde edilmesine yardımcı olacaktır.
- Açık bekletme süresi içerisinde karolar taraklanan harç üzerine hafifçe yüzdürülerek seviyelenmeli ve lastik çekiç yardımıyla kuvvet uygulayarak yapıştırılmalıdır.
- Rüzgarlı havalarda ve yüksek sıcaklık ortamında uygulama yapılması harçta su kaybına neden olması ve yüzeyin kuruması nedeniyle açık bekletme sürelerini düşürebilir. Rüzgarlı veya çok sıcak havalarda mümkün olduğunca uygulamadan kaçınılmalıdır.
- Yüze çekilmiş harcin süresi dolmuşsa harç kazınarak atılmalı ve yeniden çekilmelidir.
- Kap ömrü dolmuş harç yeniden su ilave edilerek kullanılmamalı veya yeni harç ile karıştırılmamalıdır.
- Uygulama yapılmış yerler 24 saat boyunca sudan ve dondan korunmalıdır.



Harcın mala yardımı ile yüzeye aktarılması



Taraklama

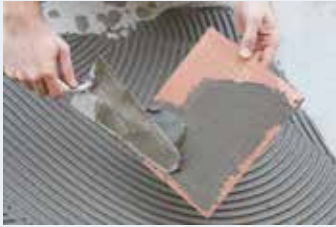

Çift taraflı yapıştırma uygulaması



Seramiğin yerleştirilmesi



Çekiçle vurulup seviyelendirilmesi

## Uyarılar

- Tozunu solumayınız, cilde ve göze temas ettirmeyiniz.
- Uygulama sonrası eller ve uygulama aletlerini bol su ile yıkayınız.
- Bulaşmış yüzeyleri nemli bir bezle kurumadan temizleyiniz.

## Depolama

- Serin ve kuru ortamda depolayınız.
- Direkt güneş ışığı altında uzun süreli bırakmayınız.

# CERAFIX

Çimento Esaslı Granit Yapıştırma Harcı  
Superadhesive Mortar For Porcelain Tiles



## Tanımı

Çimento esaslı, polimer takviyeli, ilave özellikleri geliştirilmiş, yüksek performanslı yapıştırıcısı.

## Uygulama Alanları

- Siva, şap, brüt beton, beton gibi çimento esaslı yüzeylerde,
- İç ve dış mekanlarda,
- Banyo, mutfak ve koridor gibi yerlerde; yatay ve düşey uygulamalarda, küçük, orijinal yer ve duvar seramikleri, dekoratif tuğla, mermer, traverten, doğal taş, cam mozaik gibi kaplama malzemelerinin yapıştırılmasında.
- Alışveriş merkezleri, ticari alanlar, okul, hastane gibi mekanların zeminlerinde (yoğun yaya trafiği olan mekanlar)

## Özellikleri

- Hazırlanması ve uygulanması kolay, ekonomik bir yapıştırıcıdır.
- Kolay taraklanır ve işleme süresi uzundur.
- Yüksek yapışma özelliği ile düşey uygulamalarda kayma yapmaz.

## Teknik Özellikleri

(23 °C ve % 50 Bağıl nem)

<b>Görünüm</b>	:	Gri veya beyaz renkli toz
<b>Raf Ömrü</b>	:	Kapalı ambalajında ve rutubetsiz ortamda 12 ay
<b>Uygulama Sıcaklığı</b>	:	(+5 °C) - (+35°C)
<b>Karışım Oranı</b>	:	6,5 - 7L su / 25 Kg
<b>Tüketim</b>	:	3-6 Kg/m <sup>2</sup>
<b>Olgunlaştırma süresi</b>	:	5 dk.
<b>Kap Ömrü</b>	:	2 saat
<b>Kullanıma alma süresi</b>	:	24 saat sonra
<b>Derz Dolgu Süresi</b>	:	24 saat sonra
<b>Sıcaklık Dayanımı</b>	:	(-20 °C) - (+ 80°C)
<b>Açık Bekletme Süresi</b>	:	(EN 1346) ≥ 0,5 N/mm <sup>2</sup> (20 dk. Sonra)
<b>Başlangıç Yapışma</b>	:	(EN 1348) ≥ 1,0 N/mm <sup>2</sup> (28 gün)
<b>Suya Daldırma sonrası</b>	:	(EN 1348) ≥ 1,0 N/mm <sup>2</sup>
<b>Isıyla Yaşlandırma sonrası</b>	:	(EN 1348) ≥ 1,0 N/mm <sup>2</sup>
<b>Donma Çözümne sonrası</b>	:	(EN 1348) ≥ 1,0 N/mm <sup>2</sup>

## Ambalaj

25 Kg Kraft torba

TS EN 12004 - C2 sınıfının öngördüğü normlara uygundur.

C = Çimento esaslı

2 = İlave özelliklerle geliştirilmiş

# UYGULAMA TALİMATLARI

## Yüzey Hazırlığı

- Uygulama yapılacak yüzey kürünü almış terazisinde, düzgün ve sağlam olmalı
- Yüzeyde yapışma performansını olumsuz etkileyecek, gevşek parçacıklar, yağ, toz, kir, parafin vs. gibi kalıntılar olmamalı,
- Gevşek yerler kırılarak temizlenmeli ve yüzeydeki boşluklar uygun bir tamir harcı ile tamir edilerek düzeltilmeli ve kürenmesi beklenmelidir.
- Yüzeyin su emiciliği yüksek ise veya sıcaklık 25 °C üzerindeyse yüzey nemlendirilmelidir.



Yüzeyin düzgünlüğünün kontrol edilmesi



Yüzeyin temizlenip nemlendirilmesi

## Karıştırma

- Uygun su miktarı (6,5 Lt) bir karıştırma kabı içerisine ölçek vasıtasıyla alınır,
- Düşük devirli (400-500 dev/dk.) bir karıştırıcı ile karıştırma yapılırken 25 Kg CERAFIX harcı yavaş yavaş su üzerine ilave edilir.
- Topaksız ve homojen bir karışım elde edinceye kadar birkaç dakika karıştırılır. (Harç içerisine uygulama talimatında belirtilmeyen herhangi bir katkı eklemeyiniz)
- 5 dakika dinlenmeye bırakılır.
- Uygulamaya başlamadan önce 1-2 dk. daha karıştırıldıktan sonra harç kullanıma hazır hale gelir.



Harcın suya eklenmesi



Karıştırıcı ile karıştırma



Homojen karışım

## Uygulama Yöntemi

- Hazırlanan harç malanın düz kısmı ile uygulama yüzeyine yayılır. Daha sonra kullanılacak karoların boyutuna uygun olarak seçilen tarak ile taraklanır.
- Harcın açık beketme süresi içerisinde (maximum 30 dk.) kaplanabilecek kadar bir alana çekilmesine dikkat edilmelidir.

- Tarakla çekme işlemi tek yönde ve eşdeğer formda olmalıdır.
- Isı değişimleri veya yoğun yaya ve yük trafiğinin olduğu yerlerde geniş ebatlı karolar için karonun arkasına yaklaşık 1mm kalınlığında düzgün olarak harç sürülmesi önerilir. Bu yöntem yüzeydeki seviye farklılıklarından kaynaklanacak hataları önleme ve daha iyi bir yapışma performansı elde edilmesine yardımcı olacaktır.
- Açık bekletme süresi içerisinde karolar taraklanan harç üzerine hafifçe yüzdürülerek seviyelenmeli ve lastik çekiç yardımıyla kuvvet uygulayarak yapıştırılmalıdır.
- Rüzgarlı havalarda ve yüksek sıcaklık ortamında uygulama yapılması harçta su kaybına neden olması ve yüzeyin kuruması nedeniyle açık bekletme sürelerini düşürebilir. Rüzgarlı veya çok sıcak havalarda mümkün olduğunca uygulamadan kaçınılmalıdır.
- Yüze çekilmiş harcın süresi dolmuşsa harç kazınarak atılmalı ve yeniden çekilmelidir.
- Kap ömrü dolmuş harç yeniden su ilave edilerek kullanılmamalı veya yeni harç ile karıştırılmamalıdır.
- Uygulama yapılmış yerler 24 saat boyunca sudan ve dondan korunmalıdır.



Harcın mala yardımı ile yüzeye aktarılması



Taraklama

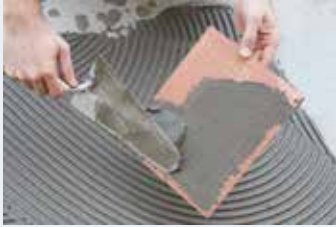

Çift taraflı yapıştırma uygulaması



Seramiğin yerleştirilmesi



Çekiçle vurulup seviyelendirilmesi

## Uyarılar

- Tozunu solumayınız, cilde ve göze temas ettirmeyiniz.
- Uygulama sonrası eller ve uygulama aletlerini bol su ile yıkayınız.
- Bulaşmış yüzeyleri nemli bir bezle kurumadan temizleyiniz.

## Depolama

- Serin ve kuru ortamda depolayınız.
- Direk güneş ışığı altında uzun süreli bırakmayınız.



# CERABOND

Çimento Esaslı Granit Yapıştırma Harcı  
Superadhesive Mortar For Porcelain Tiles



## Tanımı

Çimento esaslı, polimer takviyeli, ilave özelliklerle geliştirilmiş, yapışma mukavemeti artırılmış, yüksek performanslı, yarı esnek, granit yapıştırıcısı.

## Uygulama Alanları

- Siva, şap, brüt beton, beton gibi çimento esaslı yüzeylerde, alçı siva, alçı blok ve alçı levha üzerine (emici yüzeyler için uygun astar kullanıldıktan sonra)
- İç ve dış mekanlarda, banyo, mutfak ve koridor gibi yerlerde; yatay ve düşey uygulamalarda, küçük, orta ve büyük ebatlı yer ve duvar seramikleri, dekoratif tuğla, mermer, traverten, doğal taş, cam mozaik gibi kaplama malzemelerinin yapıştırılmasında.
- Alışveriş merkezleri, ticari alanlar, okul, hastane gibi mekanların zeminlerinde (yoğun yaya trafiği olan mekanlar) işletme, fabrika, atölye zeminlerinde
- Eski seramik üstü seramik kaplamalarda mükemmel yapışma sağlar. (Seramik yüzeyine akrilik astar çekilmesi uygulama kolaylığı açısından tavsiye edilir)

## Özellikleri

- Hazırlaması ve uygulanması kolay bir yapıştırıcıdır. Kolay taraklanır ve işleme süresi uzundur.
- Yüksek yapışma özelliği ile düşey uygulamalarda kayma yapmaz.

## Teknik Özellikleri (23 °C ve % 50 Bağıl nem)

<b>Görünüm</b>	: Gri renkli toz
<b>Raf Ömrü</b>	: Kapalı ambalajında ve rutubetsiz ortamda 12 ay
<b>Uygulama Sıcaklığı</b>	: (+5 °C) - (+35 °C)
<b>Karışım Oranı</b>	: 6,5 -7L su / 25 Kg
<b>Tüketim</b>	: 3-6 Kg/m <sup>2</sup>
<b>Olgunlaştırma süresi</b>	: 5 dk.
<b>Kap Ömrü</b>	: 2 saat
<b>Kullanıma alma süresi</b>	: 24 saat sonra
<b>Derz Dolgu Süresi</b>	: 24 saat sonra
<b>Sıcaklık Dayanımı</b>	: (-20 °C) - (+ 80 °C)
<b>Kayma</b>	: (EN 1308) ≤ 0,5 mm
<b>Açık Bekletme Süresi</b>	: (EN 1346) ≥ 0,5 N/mm <sup>2</sup> (30 dk. Sonra)
<b>Başlangıç Yapışma</b>	: (EN 1348) ≥ 1,0 N/mm <sup>2</sup> (28 gün)
<b>Suya Daldırma sonrası</b>	: (EN 1348) ≥ 1,0 N/mm <sup>2</sup>
<b>Isıyla Yaşlandırma sonrası</b>	: (EN 1348) ≥ 1,0 N/mm <sup>2</sup>
<b>Donma Çözümne sonrası</b>	: (EN 1348) ≥ 1,0 N/mm <sup>2</sup>

## Ambalaj

25 Kg Kraft torba

TS EN 12004 - C2TE sınıfının öngördüğü normlara uygundur.

C = Çimento esaslı 2 = İlave Özelliklerle geliştirilmiş T = Kayma özelliği azaltılmış E = Açık bekleme süresi uzatılmış

# UYGULAMA TALİMATLARI

## Yüzey Hazırlığı

- Uygulama yapılacak yüzey kürünü almış terazisinde, düzgün ve sağlam olmalı,
- Yüzeyde yapışma performansını olumsuz etkileyecek, gevşek parçacıklar, yağ, toz, kir, parafin vs. gibi kalıntılar olmamalı,
- Gevşek yerler kırılarak temizlenmeli ve yüzeydeki boşluklar uygun bir tamir harcı ile tamir edilerek düzeltilmeli ve kürlenmesi beklenmelidir.
- Yüzeyin su emiciliği yüksek ise veya sıcaklık 25°C üzerindeyse yüzey nemlendirilmelidir.



Yüzeyin düzgünlüğünün kontrol edilmesi



Yüzeyin temizlenip nemlendirilmesi

## Karıştırma

- Uygun su miktarı (6,5 Lt) bir karıştırma kabı içerisine ölçek vasıtasıyla alınır,
- Düşük devirli (400-500 dev/dk.) bir karıştırıcı ile karıştırma yapılırken 25 Kg CERABOND harcı yavaş yavaş su üzerine ilave edilir.
- Topaksız ve homojen bir karışım elde edinceye kadar birkaç dakika karıştırılır. (Harç içerisine uygulama talimatında belirtilmeyen herhangi bir katkı eklemeyiniz)
- 5 dakika dinlenmeye bırakılır.
- Uygulamaya başlamadan önce 1-2 dk. daha karıştırıldıktan sonra harç kullanıma hazır hale gelir.



Harcın suya eklenmesi



Karıştırıcı ile karıştırma



Homojen karışım

## Uygulama Yöntemi

- Hazırlanan harç malanın düz kısmı ile uygulama yüzeyine yayılır. Daha sonra kullanılacak karoların boyutuna uygun olarak seçilen tarak ile taraklanır.
- Harcın açık bekleme süresi içerisinde (maximum 30 dk.) kaplanabilecek kadar bir alana çekilmesine dikkat edilmelidir.

- Tarakla çekme işlemi tek yönde ve eşdeğer formda olmalıdır.
- Isı değişimleri veya yoğun yaya ve yük trafiğinin olduğu yerlerde geniş ebatlı karolar için karonun arkasına yaklaşık 1mm kalınlığında düzgün olarak harç sürülmesi önerilir. Bu yöntem yüzeydeki seviye farklılıklarından kaynaklanacak hataları önleme ve daha iyi bir yapışma performansı elde edilmesine yardımcı olacaktır.
- Açık bekletme süresi içerisinde karolar taraklanan harç üzerine hafifçe yüzdürülerek seviyelenmeli ve lastik çekiç yardımıyla kuvvet uygulayarak yapıştırılmalıdır.
- Rüzgarlı havalarda ve yüksek sıcaklık ortamında uygulama yapılması harçta su kaybına neden olması ve yüzeyin kuruması nedeniyle açık bekletme sürelerini düşürebilir. Rüzgarlı veya çok sıcak havalarda mümkün olduğunca uygulamadan kaçınılmalıdır.
- Yüze çekilmiş harcın süresi dolmuşsa harç kazınarak atılmalı ve yeniden çekilmelidir.
- Kap ömrü dolmuş harç yeniden su ilave edilerek kullanılmamalı veya yeni harç ile karıştırılmamalıdır.
- Uygulama yapılmış yerler 24 saat boyunca sudan ve dondan korunmalıdır.



Harcın mala yardımı ile yüzeye aktarılması



Tararlama

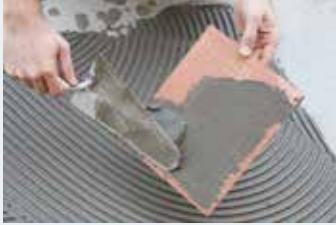

Çift taraflı yapıştırma uygulaması



Seramiğin yerleştirilmesi



Çekiçle vurulup seviyelendirilmesi

## Uyarılar

- Tozunu solumayınız, cilde ve göze temas ettirmeyiniz.
- Uygulama sonrası eller ve uygulama aletlerini bol su ile yıkayınız.
- Bulaşmış yüzeyleri nemli bir bezle kurumadan temizleyiniz.

## Depolama

- Serin ve kuru ortamda depolayınız.
- Direk güneş ışığı altında uzun süreli bırakmayınız.

# CERAFLEX

Granit ve Seramik için Esnek Yapıştırma Harcı  
*Flex superadhesive mortar for Granite and Ceramic*



## Tanımı

Çimento esaslı, polimer katkı, yüksek performanslı, kayma özelliği azaltılmış, uzun çalışma süresine sahip, esnek yapılı yapıştırma harcıdır.

## Uygulama Alanları

- İç ve dış mekanlarda, yatay ve düşey uygulamalarda
- Yer ve duvar seramikleri, granit, mermer, traverten, doğal taş, dekoratif tuğlalar, cam mozaikler gibi kaplama malzemelerinin sıcaklık farkları etkisi altındaki beton, sıva, şap gibi yüzeylere yapıştırılmasında,
- Binaların dış cephelerinin kaplanmasında, tadilat ve onarım sırasında eski seramik, granit üzerine seramik kaplamalarda,
- Alçı sıva, alçı-kartonplak, ısı izolasyon plakaları, boya (yapışma mukavemeti iyi olan), gaz beton gibi ısı farklılıklarından etkilenen yüzeyler üzerine yapıştırma uygulamalarında, (emici yüzeyler uygulama öncesi astarlanmalıdır)
- Geniş aralıklı ısı değişimlerinin olduğu, yerden ısıtılmalı sistemlerde, soğuk hava ve şoklama depolarının duvar ve zeminlerinde, termal havuzlarda, fırınların dış duvarlarında,
- Teras, balkon, banyo, su deposu, havuz, gibi ıslak mekanlarda
- Yaya ve yük trafiğinin yoğun olduğu iş merkezleri, okul, hastane, alışveriş merkezlerinde kullanılır.

## Özellikleri

- Hazırlaması ve uygulanması kolaydır.
- Kolay taraklanır ve işleme süresi uzundur.
- Yüksek yapışma özelliği ile düşey uygulamalarda kayma yapmaz.
- Esnek özelliği nedeniyle donma ve çözünme döngüsüne, sıcaklık değişimlerinden kaynaklanan yüzey gerilmelerine ve titreşimlere karşı dayanıklıdır.

TS EN 12004

C2TE/S1 sınıfının öngördüğü normlara uygundur.

C = Çimento esaslı

2 = İlave özellikleri geliştirilmiş, yüksek performanslı

T = Kayma özelliği azaltılmış

E = Uzatılmış çalışma süresi

S1= Esnek

## Teknik Özellikleri (23 °C ve % 50 Bağıl nem)

<b>Görünüm</b>	: Gri ve Beyaz renklere toz
<b>Raf Ömrü</b>	: Kapalı ambalajında ve rutubetsiz ortamda 12 ay
<b>Uygulama Sıcaklığı</b>	: (+5 °C) - (+35 °C)
<b>Karışım Oranı</b>	: 6,5 L su / 25 Kg
<b>Tüketim</b>	: 3-6 Kg/m <sup>2</sup>
<b>Olgunlaştırma süresi</b>	: 5 dk.
<b>Kap Ömrü</b>	: 2 saat
<b>Üzerinde yürünebilme süresi</b>	: 24 saat sonra
<b>Kullanıma alma süresi</b>	: 48 saat sonra
<b>Derz Dolgu Süresi</b>	: 24 saat sonra
<b>Sıcaklık Dayanımı</b>	: (-20 °C) - (+ 80 °C)

<b>Kayma</b>	: (EN 1308)	≤ 0,5 mm
<b>Açık Bekletme Süresi</b>	: (EN 1346)	≥ 0,5 N/mm <sup>2</sup>
<b>Başlangıç Yapışma</b>	: (EN 1348)	≥ 1,0 N/mm <sup>2</sup> (28 gün)
<b>Suya Daldırma sonrası</b>	: (EN 1348)	≥ 1,0 N/mm <sup>2</sup>
<b>Isıyla Yaşlandırma sonrası</b>	: (EN 1348)	≥ 1,0 N/mm <sup>2</sup>
<b>Donma Çözünme sonrası</b>	: (EN 1348)	≥ 1,0 N/mm <sup>2</sup>
<b>Enine Deformasyon</b>	: (EN 12002)	2.5 ≤ S1 ≤ 5 mm <sup>2</sup>

## Ambalaj

25 Kg Kraft torba

# UYGULAMA TALİMATLARI

## Yüzey Hazırlığı

- Uygulama yapılacak yüzey kürünü almış terazisinde, düzgün ve sağlam olmalı,
- Yüzeyde yapışma performansını olumsuz etkileyecek, gevşek parçacıklar, yağ, toz, kir, parafin vs. gibi kalıntılar olmamalı,
- Gevşek yerler kırılarak temizlenmeli ve yüzeydeki boşluklar uygun bir tamir harcı ile tamir edilerek düzeltilmeli ve kürenmesi beklenmelidir.
- Yüzeyin su emiciliği yüksek ise veya sıcaklık 25 °C üzerindeyse yüzey nemlendirilmelidir.
- Alçı esaslı yüzeylere uygulama yapılmadan önce yüzey uygun bir astar malzemesi kullanılarak astarlanmalıdır.



Yüzeyin düzgünlüğünün kontrol edilmesi



Yüzeyin temizlenip nemlendirilmesi

- Astar yapılmış yüzey kullanım talimatında yazılı kuruma süresi dolmadan yapıştırma uygulamasına geçilmemelidir. (minimum 24 saat )
- Ahşap yonga levhalar üzerine yapılacak uygulamalarda yüzeyin uygun şekilde astarlanması gerekir.
- Levhaların monte edildiği yerde zamanla nem ve rutubet almaması için gerekli önlemlerin alınması gerekir.

## Karıştırma

- Uygun su miktarı (6,5 Lt) bir karıştırma kabı içerisine ölçek vasıtasıyla alınır,
- Düşük devirli (400-500 dev/dk.) bir karıştırıcı ile karıştırma yapılırken 25 Kg CERAFLEX harcı yavaş yavaş su üzerine ilave edilir.
- Topaksız ve homojen bir karışım elde edinceye kadar birkaç dakika karıştırılır. (Harç içerisine uygulama talimatında belirtilmeyen herhangi bir katkı eklemeyiniz)
- 5 dakika dinlenmeye bırakılır.
- Uygulamaya başlamadan önce 1-2 dk. daha karıştırıldıktan sonra harç kullanıma hazır hale gelir.



Harcın suya eklenmesi



Karıştırıcı ile karıştırma



Homojen karışım

## Uygulama Yöntemi

- Hazırlanan harç malanın düz kısmı ile uygulama yüzeyine yayılır. Daha sonra kullanılacak karoların boyutuna uygun olarak seçilen tarak ile taraklanır.
- Harcın açık bekleme süresi içerisinde (maximum 30 dk.) kaplanabilecek kadar bir alana çekilmesine dikkat edilmelidir.

- Tarakla çekme işlemi tek yönde ve eşdeğer formda olmalıdır.
- Isı değişimleri veya yoğun yaya ve yük trafiğinin olduğu yerlerde geniş ebatlı karolar için karonun arkasına yaklaşık 1mm kalınlığında düzgün olarak harç sürülmesi önerilir. Bu yöntem yüzeydeki seviye farklılıklarından kaynaklanacak hataları önleme ve daha iyi bir yapışma performansı elde edilmesine yardımcı olacaktır.
- Açık bekletme süresi içerisinde karolar taraklanan harç üzerine hafifçe yüzdürülerek seviyelenmeli ve lastik çekiç yardımıyla kuvvet uygulayarak yapıştırılmalıdır.
- Rüzgarlı havalarda ve yüksek sıcaklık ortamında uygulama yapılması harçta su kaybına neden olması ve yüzeyin kuruması nedeniyle açık bekletme sürelerini düşürebilir. Rüzgarlı veya çok sıcak havalarda mümkün olduğunca uygulamadan kaçınılmalıdır.
- Yüzeye çekilmiş harcın süresi dolmuşsa harç kazınarak atılmalı ve yeniden çekilmelidir.
- Kap ömrü dolmuş harç yeniden su ilave edilerek kullanılmamalı veya yeni harç ile karıştırılmamalıdır.
- Uygulama yapılmış yerler 24 saat boyunca sudan ve dondan korunmalıdır.



Harcın mala yardımı ile yüzeye aktarılması



Taraklama

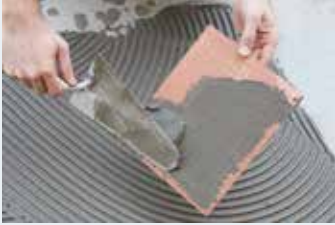

Çift taraflı yapıştırma uygulaması



Seramiğin yerleştirilmesi



Çekiçle vurulup seviyelendirilmesi

## Uyarılar

- Tozunu solumayınız, cilde ve göze temas ettirmeyiniz.
- Uygulama sonrası eller ve uygulama aletlerini bol su ile yıkayınız.
- Bulaşmış yüzeyleri nemli bir bezle kurumadan temizleyiniz.

## Depolama

- Serin ve kuru ortamda depolayınız.
- Direk güneş ışığı altında uzun süreli bırakmayınız.

# CERA FILL

Silikonlu, Renkli Derz Dolgu (1 - 6 mm)  
Grout For Wall & Floor Ceramic Tiles



## Tanımı

Çimento esaslı, silikon katkılı, Seramik ve fayans derzleri için dekoratif ve yüksek performanslı derz dolgu malzemesidir.

## Uygulama Alanları

- Seramik, granit, mermer, cam mozaik, doğal taş, cotto gibi kaplama malzemelerinin 1-6 mm arasındaki derz boşluklarının doldurulmasında,
- Mutfak, banyo, duş, tuvalet gibi ıslak hacimler ve kolay kirlenebilen yerlerde,
- Düşey ve yatay uygulamalarda,
- Konut, alışveriş merkezleri ve otellerde kullanılır.

## Özellikleri

- Hazırlaması ve uygulaması kolaydır.
- Silikon katkısı nedeniyle suyu iter,
- Çatlamadan yapışma sağlar,
- Kolay temizlenir
- Düzgün yüzey sağlar ve aşınmalara karşı dayanıklıdır

## Teknik Özellikleri (23 °C ve % 50 Bağıl nem)

<b>Görünüm</b>	:	11 farklı renk seçeneği
<b>Raf Ömrü</b>	:	Kapalı ambalajında ve rutubetsiz ortamda 12 ay
<b>Uygulama Bilgileri</b>		
<b>Uygulama Sıcaklığı</b>	:	(+5 °C) - (+35 °C)
<b>Karışım Oranı</b>	:	6,5 - 7lt su/ 20 Kg
<b>Tüketim</b>	:	Seramik ebatına göre değişkendir.
<b>Olgunlaştırma süresi</b>	:	5 dk.
<b>Kap Ömrü</b>	:	1 saat
<b>Kullanıma alma süresi</b>	:	24 saat sonra
<b>Dayanıklılık Bilgileri</b>		
<b>Eğilme Dayanımı</b>	:	(EN 12808-3) ≥ 3,5 N/mm <sup>2</sup>
<b>Basınç Dayanımı</b>	:	(EN 12808-3) ≥ 15 N/mm <sup>2</sup>
<b>Aşınma Dayanımı</b>	:	(EN 12808-2) ≤ 1000 mm <sup>3</sup>
<b>Büzülme</b>	:	(EN 12808-4) ≤ 3 mm/m
<b>Su Emme</b>	:	(EN 12808-5) 30 dk. da ≤ 2 g    240 dk. da ≤ 5 g
<b>Sıcaklık Dayanımı</b>	:	(- 30 °C) - (+ 80 °C)

## Sarfiyat Tablosu

Seramik Ebatı (cm)	Derz Genişliğine göre Sarfiyatlar (g/m <sup>2</sup> )				
	2mm	3mm	4mm	5mm	6mm
10x10	550	700	900	1.200	1.500
20x20	300	450	550	750	850
25x40	200	300	380	500	550
33x33	200	280	350	450	500
45x45	150	200	250	300	400

### Ambalaj

20 Kg ve 10 Kg Kraft torbalarda

TS EN 13888 CG2W sınıfının normlarını sağlar

C = Çimento esaslı

G = Derz dolgu

2 = Yüksek performanslı

W= Azaltılmış su emme özelliği

## UYGULAMA TALİMATLARI

### Yüzey Hazırlığı

- Derz dolgu uygulaması yapılacak yüzeyde yapıştırıcının kürlenme işlemi bitmiş olmalıdır.
- Derz aralıkları dolgunun yerleşmesini engelleyecek iri parçalardan, veya derzin tutunmasını önleyecek toz ve kirlere mutlakla temizlenmiş olmalıdır.
- Derz derinlikleri seramik kalınlığının en az 2/3 ü kadar olmalıdır.
- Su emiciliği yüksek kaplama malzemelerinin kullanılması, uygulama yapılacak ortamın çok sıcak veya rüzgarlı olması, uygulanan derzin hızlı su kaybetmesine neden olacağı için çatlama ve tozumlara neden olacaktır. Bu şartlarda derz uygulaması yapılmadan önce derz aralıkları temiz su ile sprey yardımıyla nemlendirilmelidir.

### Karıştırma

- 20 Kg derz için ortalama 7 Lt suya ihtiyaç olacaktır. Kullanılacak harç miktarına yetecek kadar su bir kaba koyularak CERAFILL üzerine yavaşça eklenir. Ekleme sırasında düşük devirli (- 400-600 devir/dk.) bir karıştırıcı ile karıştırılır. Homojen bir karışım elde edilinceye kadar karıştırmaya devam edilir. Harcın suyu belirtilen aralıklarda koyulmalıdır. Fazla veya eksik su uygulama sonrası derz yüzeyinde çatlaklar, tozuma sorunu ve renkli derzlerde renk kusurlarına neden olacaktır.
- Harç olgunlaşması için 5-10 dakika beklenir. Sonra 1-2dk daha karıştırılır.



Harcın suya eklenmesi



Karıştırıcı ile karıştırma



Homojen karışım



## Uygulama Yöntemi

- Hazırlanan harç lastik bir mala yardımıyla derz aralıklarına önce paralel daha sonra çaprazlama gelecek şekilde çekilerek doldurulur. Fazla kısımlar sıyrılarak alınır.
- Derz dolgunun suyunu çekerek matlaşması ve parmak baskısına dayanır hale gelmesi halinde nemli bir sünger ile tüm yüzey dairesel hareketlerle silinerek temizlenir, derz yüzeyleri düzeltilir. Hava sıcaklığına bağlı olarak 20-30 dk sonra derz nemlendirilerek hidrasyon için can suyu verilmesi çatlama ve tozumu önler.
- Çok sıcak havalarda 1 saat sonra tekrar yüzeye spreyleme ile nemlendirme fayda sağlar.
- Renkli derz dolgu uygulamalarında çok sulu sünger kullanılması yüzeyde renk farklılıklarına neden olabilir.
- Derz dolgunun çıkmayacak kadar priz aldığından emin olduktan sonra yüzeydeki kalıntılar tamamen temizlenmelidir.
- Hazırlanan harç teknik talimatlarda belirtilen sürede kullanılmalıdır. Süresi geçen harç atılmalı ve yenisi hazırlanmalıdır. Süresi geçmiş harç sulandırılarak veya yeni harca katılarak kesinlikle kullanılmamalıdır.



Dolgu malzemesinin duvara uygulanması



Nemli sünger ile derz yüzeyinin düzeltilmesi

## Uyarılar

- Tozunu solumayınız, cilde ve göze temas ettirmeyiniz.
- Uygulama sonrası eller ve uygulama aletlerini bol su ile yıkayınız.
- Bulaşmış yüzeyleri nemli bir bezle kurumadan temizleyiniz.

## Depolama

- Serin ve kuru ortamda depolayınız.
- Direk güneş ışığı altında uzun süreli bırakmayınız.

# Seramik uygulaması İpuçları

## Düğüün olmayan zeminlerde uygulama nasıl yapılır?

Bozuk zeminler üzerinde seramik uygulaması yapılması seramiğin uzun ömürlü ve kullanışlı olmasını engelleyebilir. Yüzey düğünlüğünün sağlanması hem estetik hem de emniyet açısından önemlidir. Standart teknikler düğüün zeminler için uygunken, tesviyesi bozuk zeminlerde uygulandığıında sorun çıkartabilir.

- Yüzeyin sağlamlığı kontrol edilmeli ve sağlam olmayan bölümler tamamen temizlenmelidir.
- Yüzeydeki yağ, toz ve çimento gibi kalıntılar suyla temizlenmelidir.
- Yüzey nemlendirildikten sonra yapıştırma harcı yüzeye uygulanıp, kalınlığı dişli çelik mala ile ayarlanmalıdır.
- İç mekan zemin uygulamalarında; 1000 cm<sup>2</sup>, duvar uygulamalarında 500 cm<sup>2</sup>'den büyük seramiklerde ve tüm dış mekan zemin uygulamalarında çift taraflı yapıştırma yöntemi kullanılmalıdır.
- Sağlam bir yapışma için lastik çekiç yardımıyla seviyelendirilmelidir.
- En az 24 saat sonra derz dolgu uygulaması yapılmalıdır.
- Belirtilen süreler 20 °C yüzey ve ortam sıcaklığında geçerlidir, daha düşük ısıda süre uzar, daha yüksek ısıda süre kısılır.
- Boyalı yüzeylere yapılacak uygulamalarda yapıştırıcının tutunma mukavemeti boyanın yüzeye tutunma mukavemetine bağlıdır. Boyanın sağlamlığı kontrol edilmelidir.



## Açık alanlarda (balkon, teras vs.) seramik uygulaması nasıl yapılır?

Evlerdeki açık alanlar (balkon, teras vs.) için seramik kaplamalar, iç mekânlardaki kaplamalara oranla çok daha yıpratıcı etkenlere maruzdurlar. Bu tür yüzeylerde iklimsel etkenler termik zarara neden olur. Yağmur suları düzenli tahliye edilmediklerinde zamanla seramik uygulamasına zarar verir.

Seramik uygulaması yapılırken öncelikle yağmur suyunun rahatlıkla tahliye edilebilmesi için gerekli zemin eğiminin verilmesi, mekanik ve termik deformasyona dayanıklı elastik bir yapıştırma harcı uygulaması ve yeterli amortisör etkisi gösterebilecek elastik bir derz dolgu harcı kullanımı uygulamayı güvence altına alınmalıdır. En önemli uyarılardan biri de uygun hava koşulunda bu uygulamayı tamamlamaktır.

CeraFlex yapıştırma harcına zemine boşaltıldıktan sonra harca oluğuna doğru min. % 1 oranında eğim verilmelidir.

Yüzey nemlendirildikten sonra seramikler CeraFlex yapıştırma harcı kullanılarak çift taraflı yapıştırma yöntemi ile uygulanmalıdır.

Her 50 m<sup>2</sup>'lik alan için en az 10 mm.'lik dilatasyon derzleri bırakılmalıdır (boyu 8 m.'yi geçmemelidir).

Ceraflex uygulamasından 24 saat sonra derzleme işlemine geçilmeli ve derz dolgusu olarak Cerafill kullanılmalıdır.

### **Zeminde Isıtma sistemi ya da ısı yalıtımı varsa seramik uygulaması nasıl yapılır?**

Zemindeki ısıtma sistemi ani ısı değişikliklerine maruz kaldıkları için yapılacak seramik uygulaması ancak doğru ürün kullanımıyla uzun ömürlü olabilir. Isıtma işlemi kaplama altına döşenen kanallar aracılığıyla sağlanmaktadır. Zeminde bulunan kanallar yüzeyin de genişmesine ya da büzülmesine sebep olur.

Seramiklerin sıcaklığa göre verdiği şekilsel daralma ve genişlemeye iyi uyum sağlayabilen, hareket edebilen CeraFlex yapıştırma harcı bu iş için uygun bir çözüm olacaktır.

Aynı şekilde, ısı yalıtımı yapılmış mekanlarda levhaları termal gerilmelerden ötürü hareketli yüzeylerdir. Isı yalıtım sistemindeki sıva katının üzerine seramik vb. yapıştırmak için alttaki ısı yalıtım levhası ile uyum sağlayabilen, elastik yapıda bir seramik yapıştırıcısı gereklidir. Ceraflex bu esnek yapıya uyum sağlayabilir ve uzun ömürlü kullanım sağlar.

### **Seramik döşenmiş bir zeminin üzerine seramik uygulaması nasıl olmalıdır?**

Seramik kaplı yüzeyinizi ihtiyaç ya da estetik nedenlerle değiştirmek istediğinizde, alttaki seramik kaplama zeminini kırmanıza gerek yoktur. Bunun için yüksek performanslı bir yapıştırma harcı olan CeraBond veya CeraFlex isteğinizi karşılayacaktır.

Mevcut kaplamanın sağlamlığından emin olunmalıdır.

Çekiç veya mala yardımı ile eski seramiklerin zemini sağlam tutup tutmadığı kontrol edilmelidir.

Oynayan seramikler tekrar yapıştırılmalı, çukur kısımlar tamir edilmeli ve boşluklar eskisinin aynı olan malzeme ile doldurulmalıdır.

Zeminde toz bulunması yapılan işlemin kalitesini düşürdüğü için, zemin, toz kalmayacak şekilde iyice yıkanmalıdır. Eski seramik üzerindeki yağ, deterjan, sabun kalıntıları (özellikle mutfak ve banyolarda yapılacak uygulamalarda) uygun bir çözücü yüzey temizleyici ile temizlenmelidir.

Yeni seramikler zemine CeraBond yapıştırma harcı ile yapıştırılmalı ve 24-48 saat arası priz alması için beklenmelidir.

Derz boşlukları Cerafill ile doldurulmalıdır.

Zemine 4 gün boyunca ağır yükler konulmamalıdır.



## **CERAFIX**

Superadhesive Mortar For Wall & Ceramic Tiles

129-131

---

## **CERAFIX**

Superadhesive Mortar For Porcelain Tiles

132-134

---

## **CERABOND**

Superadhesive Mortar For Porcelain Tiles

135-137

---

## **CERAFLEX**

Flex superadhesive mortar for Granite and Ceramic

138-140

---

## **CERAFILL**

Grout For Wall & Floor Ceramic Tiles

141-143

---

Tips for Ceramic Application

144-145

---

# CERAFIX

Superadhesive Mortar For Wall & Ceramic Tiles



## Description

It is cement-based ceramic, wall tile and marble adhesive mortar with reduced sliding property.

## Application Areas

- On surfaces like concrete, plaster and cement finish
- Baths, kitchens, and halls horizontal and vertical applications, and for adhesion of coating materials such as small and medium sized floor and wall ceramic tiles, decorative brick, marble, travertine, and natural stone.

## Properties

- It is an economic adhesive that is easily prepared and applied.
- It is easily combed and provides long-time processing.
- Thanks to its super adhesive property, it prevents sliding on vertical applications.

## Technical Properties

(23°C and 50 % Relative Humidity)

<b>Appearance</b>	:	Grey color powder
<b>Shelf Life</b>	:	12 months in its unopened package and in moisture-free environment
<b>Application Temperature</b>	:	(+5°C) - (+35°C)
<b>Mixture Ratio</b>	:	6,5 - 7 l water / 25 kg
<b>Consumption</b>	:	3-6 Kg/m <sup>2</sup>
<b>Duration for Maturation</b>	:	5 min.
<b>Pot Life</b>	:	2 hours
<b>Duration for Putting Into Usage</b>	:	After 24 hours
<b>Duration for Grouting</b>	:	After 24 hours
<b>Temperature Resistance</b>	:	(-20°C) - (+ 80°C)
<b>Application Thickness</b>	:	3 - 10 mm
<b>Duration for Retention As Opened</b>	:	(EN 1346) ≥ 0,5 N/mm <sup>2</sup> (after 20 min.)
<b>Beginning Adhesion</b>	:	(EN 1348) ≥ 0,5 N/mm <sup>2</sup> (28 days)
<b>After Immersion</b>	:	(EN 1348) ≥ 0,5 N/mm <sup>2</sup>
<b>After Aging with Heat</b>	:	(EN 1348) ≥ 0,5 N/mm <sup>2</sup>
<b>After Freezing and Thawing</b>	:	(EN 1348) ≥ 0,5 N/mm <sup>2</sup>

## Package

25 kg Kraft sack

It complies with the norms provided by TS EN 12004 - C1 class.

C = Cement-based      1 = Normally-hardening

# APPLICATION INSTRUCTIONS

## Surface Preparation

- The surface of application must be smooth and sound on the cured weigh,
- Residuals like loose particles, grease, dust, dirt, and paraffin which may adversely affect the adhesion performance must be removed from the surface,
- Loose parts must be broken and cleaned and surface gaps must be fixed with a suitable repair mortar and left for it to be cured.
- If water absorption property of the surface is high, or temperature is over 25°C, the surface must be moisturized.



Controlling surface smoothness



Cleaning and moisturizing the surface

## Mixing

- Pour an adequate amount of water (6,5 l) into a mixing bowl with a scale,
- While mixing process is performed with a low-speed (400-500 cyc/min.) mixer, add 25 kg CERAFIX mortar gradually.
- Mix for a few minutes until smooth and homogeneous mixture is obtained. (Please do not add any additive that is not specified in the application instructions into the mortar.)
- Left the mixture to mature for 5 minutes.
- Before starting the application, mix the mortar for 1-2 minutes more so that it is ready for usage.



Adding mortar to the water



Mixing with a mixer



Homogeneous mixture

## Application Method

- Spread mortar through the application surface by using the smooth side of trowel. Then, comb the mortar with a comb that is suitable for the size of tiles.
- Please consider drawing the mortar on a close area so that it can be covered within the open retention time (maximum 30 min.)

- Combing must be made unidirectionally and equivalently.
- In places where heat change is frequent or foot or load traffic is dense, it is recommended to apply mortar on the back of tile in approximately 1 mm of thickness for large-size tiles. This method will help you prevent the errors from level differences on the surface and obtain a far more adhesion performance.
- Tiles must be leveled on the combed mortar by slightly floating within open retention time and adhered by using force with a rubber hammer.
- Application in windy weather and an environment with high temperature might reduce open retention time due to loss of water in the mortar and surface drying. Therefore, avoid applying in windy or extremely hot weather as far as possible.
- If time of mortar applied on surface expires, mortar must be scratched and removed, then reapplied.
- Mortar with expired pot life must not be reused by adding water, or mixed with new mortar.
- Applied surfaces must be protected against water and frost for 24 hours.



Spreading mortar through the surface with a trowel



Combing

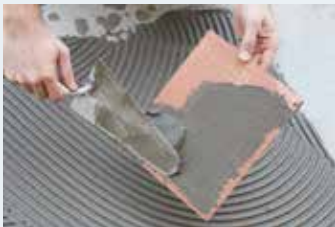

Applying double-faced adhesion



Placing the ceramic tile



Leveling with a hammer

## Warnings

- Avoid inhalation or skin and eye contact.
- Wash your hands and application tools with plenty of water after application.
- Wipe away the residuals on the surface with a damp cloth without drying.

## Storage

- Store in a cool and dry place.
- Do not left under direct sunlight for a long time.

# CERAFIX

Superadhesive Mortar For Porcelain Tiles



## Description

Cement-based, polymer-reinforced, high-performance adhesive for porcelain tile: oped additional properties.

## Application Areas

- On cement-based surfaces like plaster, cement finish, gross concrete, and concret
- Indoor and outdoor
- Baths, kitchens and halls; horizontal and vertical applications, and for adhesion materials such as small- and medium-sized floor and wall ceramic tiles, decorative brick, marble, travertine, natural stone, and glass mosaic.
- On the floors of places such as shopping malls, commercial areas, schools, and hospitals (the places with dense foot traffic)

## Properties

- It is an economic adhesive that is easily prepared and applied.
- It is easily combed and processing time is long.
- Thanks to its super adhesive property, it prevents sliding on vertical applications.

## Technical Properties

(23° C and 50 % Relative Humidity)

<b>Appearance</b>	:	Grey or White color powder
<b>Shelf Life</b>	:	12 months in moisture-free environment as
<b>Application Temperature</b>	:	unopened (+5°C) - (+35°C)
<b>Mixture Ratio</b>	:	6,5 - 7 l water / 25 kg
<b>Consumption</b>	:	3-6 Kg/m <sup>2</sup>
<b>Duration for Maturation</b>	:	5 min.
<b>Pot Life</b>	:	2 hours
<b>Duration for Putting Into Usage</b>	:	After 24 hours
<b>Duration for Grouting</b>	:	After 24 hours
<b>Temperature Resistance</b>	:	(-20 °C) - (+ 80°C)
<b>Duration for Retention As Opened</b>	:	(EN 1346) ≥ 0,5 N/mm <sup>2</sup> (after 20 min.)
<b>Beginning Adhesion</b>	:	(EN 1348) ≥ 1,0 N/mm <sup>2</sup> (28 days)
<b>After Immersion</b>	:	(EN 1348) ≥ 1,0 N/mm <sup>2</sup>
<b>After Aging with Heat</b>	:	(EN 1348) ≥ 1,0 N/mm <sup>2</sup>
<b>After Freezing and Thawing</b>	:	(EN 1348) ≥ 1,0 N/mm <sup>2</sup>

## Package

25 kg Kraft sack

It complies with the norms provided by TS EN 12004 - C2 class.

C = Cement-based                      2 = Developed with additional properties



# APPLICATION INSTRUCTIONS

## Surface Preparation

- The surface of application must be smooth and sound on the cured weigh
- Residuals like loose particles, grease, dust, dirt, and paraffin which may adversely affect the adhesion performance must be removed from the surface,
- Loose parts must be broken and cleaned and surface gaps must be fixed with a suitable repair mortar and left for it to be cured.
- If water absorption property of the surface is high, or temperature is over 25°C, the surface must be moisturized.



Controlling surface smoothness



Cleaning and moisturizing the surface

## Mixing

- An adequate amount of water (6,5 l) is poured into a mixing bowl with a scale,
- While mixing process is performed with a low-speed (400-500 cyc/min.) mixer, 25 kg CERAFIX mortar is added gradually.
- A few minutes of mixing is needed until smooth and homogeneous mixture is obtained. (Please do not add any additive that is not specified in the application instructions into the mortar)
- Left the mixture to mature for 5 minutes.
- Before starting the application, mix the mortar for 1-2 minutes more so that it is ready for usage.



Adding mortar to the water



Mixing with a mixer



Homogeneous mixture

## Application Method

- Mortar is spread through the application surface with the smooth side of trowel. Then, comb the mortar with a comb that is suitable for the size of tiles.
- Please consider drawing the mortar on a close area so that it can be covered within the open retention time (maximum 30 min.)

- Combing must be made unidirectionally and equivalently.
- In places where heat change is frequent or foot or load traffic is dense, it is recommended to apply mortar on the back of tile in approximately 1 mm of thickness for large-size tiles. This method will help you prevent the errors from level differences on the surface and obtain a far more adhesion performance.
- Tiles must be leveled on the combed mortar by slightly floating within open retention time and adhered by using force with a rubber hammer.
- Application in windy weather and an environment with high temperature might reduce open retention time due to loss of water in the mortar and surface-drying. Therefore, avoid applying in windy or extremely hot weather as far as possible.
- If time of mortar applied on surface expires, mortar must be scratched and removed, then reapplied.
- Mortar with expired pot life must not be reused by water addition, or mixed with a new mortar.
- Applied surfaces must be protected against water and frost for 24 hours.



Spreading mortar through the surface with a trowel



Combing

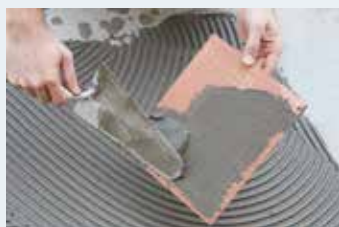

Applying double-faced adhesion



Placing the ceramic tile



Leveling with a hammer

## Warnings

- Avoid inhalation or skin and eye contact.
- Wash your hands and application tools with plenty of water.
- Wipe away the residuals on the surface with a damp cloth without drying.

## Storage

- Store in a cool and dry place.
- Do not left under direct sun light for a long time.

# CERABOND

Superadhesive Mortar For Porcelain Tiles



## Description

Cement-based, polymer-reinforced, high-performance, semi-flexible adhesive for porcelain tiles with developed additional properties and increased adhesion strength.

## Application Areas

- On cement-based surfaces like plaster, cement finish, gross concrete, and concrete, on gypsum plaster, gypsum block or gypsum board (after suitable plaster is used for absorbing surfaces)
- Indoor and outdoor, baths, kitchens and halls; horizontal and vertical applications, and for adhesion of coating materials such as small- and medium-sized floor and wall ceramic tiles, decorative brick, marble, travertine, natural stone, and glass mosaic.
- On the floors of places such as shopping malls, commercial areas, schools, and hospitals (the places with dense foot traffic), floors of entities, factories, and workshops
- It provides a perfect adhesion over old top-ceramic coatings. (Applying acrylic plaster on the ceramic surface is recommended for easy application)

## Properties

- It is an adhesive that is easily prepared and applied. It is easily combed and processing time is long.
- Thanks to its super adhesive property, it prevents sliding on vertical applications.

## Technical Properties (23°C and 50 % Relative humidity)

<b>Appearance</b>	:	Grey color powder	
<b>Shelf Life</b>	:	12 months in its unopened package and in moisture-free environment	
<b>Application</b>	:	(+5°C) - (+35°C)	
<b>Temperature Mixture Ratio</b>	:	6,5 -7 l water / 25 kg	
<b>Consumption</b>	:	3-6 kg/m <sup>2</sup>	
<b>Duration for Maturation</b>	:	5 min.	
<b>Pot Life</b>	:	2 hours	
<b>Duration for Putting Into</b>	:	After 24 hours	
<b>Usage Duration for Grouting</b>	:	After 24 hours	
<b>Temperature Resistance</b>	:	(-20°C) - (+ 80°C)	
<b>Sliding</b>	:	(EN 1308)	≤ 0,5 mm
<b>Duration for Retention As</b>	:	(EN 1346)	≥ 0,5 N/mm <sup>2</sup> (After 30 min.)
<b>Opened Beginning Adhesion</b>	:	(EN 1348)	≥ 1,0 N/mm <sup>2</sup> (28 days)
<b>After Immersion</b>	:	(EN 1348)	≥ 1,0 N/mm <sup>2</sup>
<b>After Aging with Heat</b>	:	(EN 1348)	≥ 1,0 N/mm <sup>2</sup>
<b>After Freezing and Thawing</b>	:	(EN 1348)	≥ 1,0 N/mm <sup>2</sup>

**Package** 25 kg Kraft sack

It complies with the norms provided by TS EN 12004 - C2TE class.

C = Cement-based 2 = Developed with Additional Properties T = Reduced Sliding Property

E = Extended Open Retention Time

# APPLICATION INSTRUCTIONS

## Surface Preparation

- The surface of application must be smooth and sound on the cured weigh,
- Residuals like loose particles, grease, dust, dirt, and paraffin which may adversely affect the adhesion performance must be removed from the surface,
- Loose parts must be broken and cleaned and surface gaps must be fixed with a suitable repair mortar and left for it to be cured.
- If water absorption property of the surface is high, or temperature is over 25°C, the surface must be moisturized.



Controlling surface smoothness



Cleaning and moisturizing the surface

## Mixing

- An adequate amount of water (6,5 l) is poured into a mixing bowl with a scale,
- While mixing process is performed with a low-speed (400-500 cyc/min.) mixer, add 25 kg CERABOND mortar gradually.
- A few minutes of mixing is needed until smooth and homogeneous mixture is obtained. (Please do not add any additive that is not specified in the application instructions into the mortar)
- Left the mixture to mature for 5 minutes.
- Before starting the application, mix the mortar for 1-2 minutes more so that it is ready for usage.



Adding mortar to the water



Mixing with a mixer



Homogeneous mixture

## Application Method

- Mortar is spread through the application surface with the smooth side of trowel. Then, comb the mortar with a comb that is suitable for the size of tiles.
- Please consider drawing the mortar on a close area so that it can be covered within the open retention time (maximum 30 min.)

- Combing must be made unidirectional and equivalent.
- In places where heat change is frequent or foot or load traffic is dense, it is recommended to apply mortar on the back of tile in approximately 1 mm of thickness for large-size tiles. This method will help you prevent the errors from level differences on the surface and obtain a far more adhesion performance.
- Tiles must be leveled on the combed mortar by slightly floating within open retention time and adhered by using force with a rubber hammer.
- Application in windy weather and an environment with high temperature might reduce open retention time due to loss of water in the mortar and surface-drying. Therefore, avoid applying in windy or extremely hot weather as far as possible.
- If time of mortar applied on surface expires, mortar must be scratched and removed, then reapplied.
- Mortar with expired pot life must not be reused by water addition, or mixed with a new mortar.
- Applied surfaces must be protected against water and frost for 24 hours.



Spreading mortar through the surface with a trowel



Combing

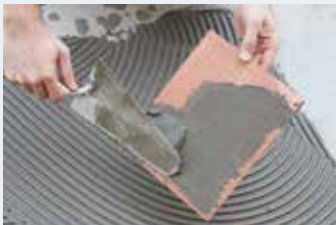

Applying double-faced adhesion



Placing the ceramic tile



Leveling with a hammer

## Warnings

- Avoid inhalation or skin and eye contact.
- Wash your hands and application tools with plenty of water.
- Wipe away the residuals on the surface with a damp cloth without drying.

## Storage

- Store in a cool and dry place.
- Do not left under direct sun light for a long time.

# CERAFLEX

*Flex superadhesive mortar for Granite and Ceramic*



## Description

It is cement-based, polymer-reinforced, high-performance and flexible adhesion mortar with reduced sliding property and long operating time.

## Application Areas

- Indoor and outdoor, horizontal and vertical applications
- For adhesion of coating materials like floor and wall ceramic tiles, porcelain tiles, marble, travertine, natural stone, decorative bricks, and glass mosaics on the surfaces such as concrete, plaster, and cement finish that is under the impact of temperature differences.
- For coating of building facades, and coating ceramic over old ceramic and porcelain tiles during repair and maintenance,
- For adhesion on surfaces that are impacted by temperature differences such as gypsum plaster, gypsum-sleeve, heat insulation plates, painting (with high adhesion strength), and gas concrete (absorbing surfaces must be undercoated before application)
- On floor-heating systems, on walls and floors of cold storage rooms and shocking storages, thermal pools, and external walls of furnaces.
- In wet places like terrace, balcony, bathroom, water tanks, and pools
- In business centers, schools, hospitals and shopping malls where foot and load traffic is dense.

## Properties

- It is easily prepared and applied.
- It is easily combed and processing time is long.
- Thanks to its super adhesive property, it prevents sliding on vertical applications.
- Thanks to its flexibility, it is resistant against freezing and thawing cycle, surface tensions and vibrations due to temperature changes.

TS EN 12004

It complies with the norms provided by C2TE/S1 class.

C = Cement-based

2 = Developed additional properties, high-performance

T = Reduced sliding property

E = Extended operating time

S1= Flexible

## Technical Properties (23°C and 50 % Relative humidity)

**Appearance** : Grey and White color powder

**Shelf Life** : 12 months in its unopened package and in moisture-free environment

**Application Temperature** : (+5°C) - (+35°C)

**Mixture Ratio** : 6,5 l water / 25 kg

**Consumption** : 3-6 kg/m<sup>2</sup>

**Duration for Maturation** : 5 min.

**Pot Life** : 2 hours

**Duration for Availability to Walk** : After 24 hours

**Duration for Putting Into Usage** : After 48 hours

**Duration for Grouting** : After 24 hours

**Temperature Resistance** : (-20°C) - (+80°C)

**Sliding** : (EN 1308) ≤ 0,5 mm

**Duration for Retention As Opened** : (EN 1346) ≥ 0,5 N/mm<sup>2</sup>

**Beginning Adhesion** : (EN 1348) ≥ 1,0 N/mm<sup>2</sup> (28 days)

**After Immersing** : (EN 1348) ≥ 1,0 N/mm<sup>2</sup>

**After Aging with Heat** : (EN 1348) ≥ 1,0 N/mm<sup>2</sup>

**After Freezing and Thawing** : (EN 1348) ≥ 1,0 N/mm<sup>2</sup>

**Lateral Deformation** : (EN 12002) 2.5 ≤ S1 ≤ 5 mm<sup>2</sup>

## Package

25 kg Kraft sack

# APPLICATION INSTRUCTIONS

## Surface Preparation

- The surface of application must be smooth and sound on the cured weigh,
- Residuals like loose particles, grease, dust, dirt, and paraffin which may adversely affect the adhesion performance must be removed from the surface,
- Loose parts must be broken and cleaned and surface gaps must be fixed with a suitable repair mortar and left for it to be cured.
- If water absorption property of the surface is high, or temperature is over 25°C, the surface must be moisturized.
- Before performing application on plaster-based surfaces, surface must be coated with a suitable plaster material.



Controlling surface smoothness



Cleaning and moisturizing the surface

- Please do not apply adhesion process on the surface coated with plaster until the end of duration for drying as written in the instructions for use. (minimum 24 hours)
- For applications on wood particle-boards, surfaces must be properly coated. Necessary measures must be taken in order to prevent moisture and humidity that will occur over time on areas where the boards are mounted

## Mixing

- An adequate amount of water (6,5 l) is poured into a mixing bowl with a scale,
- While mixing process is performed with a low-speed (400-500 cyc/min.) mixer, add 25 kg CERAFLEX mortar gradually.
- A few minutes of mixing is needed until smooth and homogeneous mixture is obtained. (Please do not add any additive that is not specified in the application instructions into the mortar)
- Left the mixture to mature for 5 minutes.
- Before starting the application, mix the mortar for 1-2 minutes more so that it is ready for usage.



Adding mortar to the water



Mixing with a mixer



Homogeneous mixture

## Application Method

- Mortar is spread through the application surface with the smooth side of trowel. Then, comb the mortar with a comb that is suitable for the size of tiles.
- Please consider drawing the mortar on a close area so that it can be covered within the open retention time (maximum 30 min.)

- Combing must be made unidirectionally and equivalently.
- In places where heat change is frequent or foot or load traffic is dense, it is recommended to apply mortar on the back of tile in approximately 1 mm of thickness for large-size tiles. This method will help you prevent the errors from level differences on the surface and obtain a far more adhesion performance.
- Tiles must be leveled on the combed mortar by slightly floating within open retention time and adhered by using force with a rubber hammer.
- Application in windy weather and an environment with high temperature might reduce open retention time due to loss of water in the mortar and surface-drying. Therefore, avoid applying in windy or extremely hot weather as far as possible.
- If time of mortar applied on surface expires, mortar must be scratched and removed, then reapplied.
- Mortar with expired pot life must not be reused by water addition, or mixed with a new mortar.
- Applied surfaces must be protected against water and frost for 24 hours.



Spreading mortar through the surface with a trowel



Combing

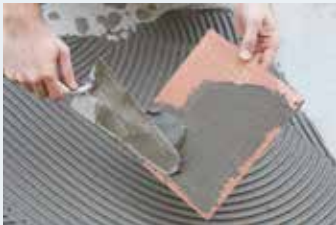

Applying double-faced adhesion



Placing the ceramic tile



Leveling with a hammer

## Warnings

- Avoid inhalation or skin and eye contact.
- Wash your hands and application tools with plenty of water.
- Wipe away the residuals on the surface with a damp cloth without drying.

## Storage

- Store in a cool and dry place.
- Do not left under direct sun light for a long time.



# CERAFILL

Grout For Wall & Floor Ceramic Tiles (1 - 6 mm)



## Description

It is a cement-based, silicone-reinforced, decorative, and high-performance grout material for wall and ceramic tiles.

## Application Areas

- For filling grout gaps of coating materials such as ceramic, porcelain tile, marble, glass mosaic, natural stone, and cotto between 1-6 mm,
- On wet areas and places that are easily polluted, such as kitchen, bathroom, shower, toilet,
- For vertical and horizontal applications,
- And in houses, shopping malls, and hotels.

## Properties

- Easily prepared and applied.
- Hydrophobic due to silicone content,
- Provides adhesion without cracks,
- Easily cleaned
- Provides a smooth surface, resistant against corrosions

## Technical Properties (23°C and 50 % Relative humidity)

<b>Appearance</b>	:	11 different color options
<b>Shelf Life</b>	:	12 months in its unopened package and in moisture-free environment
<b>Application Information</b>		
<b>Application Temperature</b>	:	(+5°C) - (+35°C)
<b>Mixture Ratio</b>	:	6,5 - 7 l water/ 20 kg
<b>Consumption</b>	:	Depends on ceramic size
<b>Duration for Maturation</b>	:	5 min.
<b>Pot Life</b>	:	1 hours
<b>Duration for Putting into Usage</b>	:	After 24 hours
<b>Resistance Information</b>	:	
<b>Bending Resistance</b>	:	(EN 12808-3) $\geq 3,5$ N/mm <sup>2</sup>
<b>Pressure Resistance</b>	:	(EN 12808-3) $\geq 15$ N/mm <sup>2</sup>
<b>Corrosion Resistance</b>	:	(EN 12808-2) $\leq 1000$ mm <sup>3</sup>
<b>Contraction</b>	:	(EN 12808-4) $\leq 3$ mm/m
<b>Water Absorption</b>	:	(EN 12808-5) Every 30 min. $\leq 2$ g      Every 240 min. $\leq 5$ g
<b>Temperature Resistance</b>	:	(- 30°C) - (+80°C)

## Consumption Table

Ceramic Size(cm)	Consumptions according to Grout Width (g/m <sup>2</sup> )				
	2mm	3mm	4mm	5mm	6mm
10x10	550	700	900	1.200	1.500
20x20	300	450	550	750	850
25x40	200	300	380	500	550
33x33	200	280	350	450	500
45x45	150	200	250	300	400

### Package

20 kg and 10 kg Kraft sacks

It complies with the norms provided by

TS EN 13888 CG2W C = Cement-based

G = Grout

2 = High-performance

W = Reduced water absorption property

## APPLICATION INSTRUCTIONS

### Surface Preparation

- The process of curing the adhesive on the surface of application must be completed.
- Joint gaps must be cleaned thoroughly, because lumps may prevent grout from locating properly and dust and dirt may prevent it from holding.
- Grout depth must be at least 2/3 of ceramic thickness.
- Use of coating materials with high water absorption property, or application in very hot or windy environment will cause grout to dehydrate quickly; therefore cracks and dusting may occur. Under these circumstances, joint gaps must be moisturized with fresh water by using a sprayer before performing grout application.

### Mixing

- 7 l water is needed for 20 kg grout. Pour water in an amount that is adequate for amount of mortar in a pot, and add CERAFILL gradually. At the same time, mix the mortar with a low-speed mixer (~ 400-600 cyc/min.) Keep mixing until you obtain a homogeneous mixture. Add water to the mortar gradually as written. Excessive or deficient amount of water will cause cracks on the surface of joints, dusting and color changes on the colored joints.
- Wait for 5-10 min. for maturation of mortar. Then, mix for 1-2 min. more.



Adding mortar  
to the water



Mixing with a mixer



Homogeneous mixture

## Application Method

- Prepared mortar is filled into the joint gaps with a rubber trowel by spreading it parallelly first, then crossingly. Excessive parts are peeled off.
- When grout absorbs water and tarnishes, and becomes resistant against finger pressure, clean the surface thoroughly circularly with a damp sponge, then fix the surfaces of grout. Depending on the air temperature, moisturize grout after 20-30 min. Giving sap for hydration prevents cracks and dusting.
- In hot weathers, remoisturizing the surface with a sprayer after 1 hour is beneficial.
- Usage of lush sponge in colored grouting applications may cause color differences on the surface.
- After ensuring grout sets adequately as it will not be removed, clean the residuals on the surface completely.
- Prepared mortar must be used within the period as specified in the technical instructions. Expired mortar must be disposed and replaced with a new one. Expired mortar must not be used by diluting or adding it into a new mortar.



Applying grouting material on the wall



Fixing the surface of joint with a damp sponge

## Warnings

- Avoid inhalation or skin and eye contact.
- Wash your hands and application tools with plenty of water.
- Wipe away the residuals on the surface with a damp cloth without drying.

## Storage

- Store in a cool and dry place.
- Do not left under direct sun light for a long time.

# Tips for Ceramic Application

## How to apply on uneven surfaces?

Applying ceramic on rough surfaces may prevent longevity and suitability of ceramic. Ensuring surface smoothness is important in terms of aesthetics and safety. While standard techniques are appropriate for smooth surface, uneven surfaces may cause problems after application.

- Surface soundness must be checked and unsound parts must be thoroughly cleaned.
- Residuals on the surface such as grease, dust, and cement must be removed with water.
- After moisturizing the surface, adhesive mortar must be applied on the surface and its thickness must be adjusted with a toothed steel trowel.
- Double-faced adhesion method must be used for indoor floor applications; 1000 cm<sup>2</sup> wall applications, areas that are bigger than 500 cm<sup>2</sup> and all outdoor floor applications.
- For a durable adhesion, rubber hammer must be used for leveling.
- Grouting application must be performed after at least 24 hours.
- Specified durations are applied to 20°C surface and environment temperature, the duration extends in lower temperature and shortens in higher temperature.
- For applications on painted surfaces, holding strength of the adhesive depends on that of painting.
- Durability of painting must be checked.



## How to apply ceramic (balcony, terrace, etc.) in the open air?

For open-air areas in houses (balcony, terrace, etc.), ceramic coatings are exposed to much more wearing factors than indoor coatings. Climatic factors may cause thermic damages on such surfaces. If not emptied regularly, rainwater damages to ceramic application over time.

While applying ceramic, it must be ensured to bevel the surface in order to empty rainwater easily, apply an elastic adhesive mortar that is resistant against mechanical and thermic deformation and use an elastic grouting mortar that takes effect as an adequate damper. One of the most important warnings is to complete this application under suitable weather conditions.

- After pouring onto the surface, CeraFlex adhesive mortar should be beveled at min 1 % percent.
- After moisturizing the surface, ceramic tiles must be applied with double-sided adhesion method by using CeraFlex adhesive mortar.
- You must leave at least 10 mm of expansion joint for each 50 m<sup>2</sup> of area.
- After 24 hours from Ceraflex application, you must skip to the grouting process and use Cerafill as joint filler.

### **If the Floor has heating system or heat insulation, how to apply ceramic tile application?**

Since heating system is exposed to sudden heat change, ceramic application must only be long-lasting with suitable product usage. Heating process is performed through ducts furnished under the coating. Ducts on the floor also cause expansion or contraction of surface.

CeraFlex adhesive mortar that can adapt to formal contraction and expansion caused by ceramic tiles according to temperature and can move will be a proper solution for this work.

In a similar manner, boards in the places with heat insulation are moving surfaces due to thermal expansions. It is required to use an elastic ceramic adhesive that can adapt to underlaid heat insulation board in order to adhere ceramic etc. onto the plaster layer in the heat insulation system. Ceraflex can adapt to this flexible structure, and provides a long-lasting usage.

### **How to apply ceramic on a surface on which ceramic tile application was made before?**

If you desire to change your surface coated with ceramic tile due to your needs or aesthetics, you do not need to break ceramic-coated floor. CeraBond or CeraFlex that are high-performance adhesive mortar will meet your needs.

- You must ensure the soundness of the current ceramic coating.
- You must check whether old ceramics hold the surface firmly by using a hammer or trowel.
- Loose ceramic tiles must be adhered again, holes must be repaired and gaps must be filled with the same material used before.
- Since dust on the surface reduces the quality of application, surface of application must be cleaned off dust. Grease, detergent, and soap residuals (especially for applications in kitchens and bathrooms) must be cleaned with a suitable solvent surface cleaner.
- New ceramic tiles must be adhered onto the surface with CeraBond adhesive mortar, and be left to set for 24-48 hours.
- Joint gaps must be filled with Cerafill.
- You must not put heavy loads on the surface for 4 days.



**C001201**  
Fayans ve Seramik Yapıştırma Harcı  
Superadhesive Mortar For Wall & Floor Tiles  
25kg Torba / Bag  
48 Torba / Bags - Palet



**C001301 Beyaz**  
**C001302 Gri**  
Granit ve Seramik için Esnek Yapıştırma Harcı  
Flex Superadhesive Mortar for Porcelain & Floor Tiles  
25kg Torba / Bag  
48 Torba / Bags - Palet



**C001202 Gri**  
**C001203 Beyaz**  
Granit Yapıştırma Harcı  
Superadhesive Mortar For Porcelain Tiles

25kg Torba / Bag  
48 Torba / Bags - Palet



**C001102 Beyaz**  
Derz Dolgu Malzemesi  
Grout for Wall & Floor Ceramic Tiles  
20kg Torba / Bag  
48 Torba / Bags - Palet



**C000110 Beyaz**  
Derz Dolgu Malzemesi  
Grout for Wall & Floor Ceramic Tiles  
10kg Torba / Bag

- C000111 Krem
- C000112 Kanyon Bej
- C000113 Anadolu Bej
- C000114 Kahve
- C000115 Gri
- C000116 Kayrak Gri
- C000117 Siyah
- C000118 Assos Bej
- C000119 Teos Gri
- C000120 Granit Gri



**C001401 Gri**  
Granit Yapıştırma Harcı  
Superadhesive Mortar For Porcelain Tiles

25kg Torba / Bag  
48 Torba / Bags - Palet

# REFERANS PROJELER

REFERENCE PROJECTS



## REFERANS PROJELER / REFERENCE PROJECTS

### PROJE ADI

LAKRISHTE KOMPLEKSI - KOSOVA  
OKUL PROJESİ - AZERBAIJAN  
DREAM VİLLA PROJESİ - BURGARİSTAN  
KATAMPE EVLERİ - NİJERYA  
WATSONS MAĞAZALARI - ADAPAZARI  
GARANTİ BANKASI - ADAPAZARI  
GRANADA HOTEL - ALANYA  
BAŞKENT ÜNİVERSİTESİ - ANKARA  
ANKAMALL AVM - ANKARA  
KAYA HOTEL - ANTALYA  
WATER SİDE HOTEL - ANTALYA  
AKDENİZ ÜNİVERSİTESİ - ANTALYA  
RİXOS HOTEL - ANTALYA  
FAUSTİNA HOTEL - AYDIN  
THERMAL HOTEL - AYDIN  
TEMİZEL HOTEL - BALIKESİR  
TEMİZEL VİLLALARI - BALIKESİR  
RAMADA HOTEL - BALIKESİR  
ÇARŞI MAĞAZALARI - DENİZLİ  
ACİBADEM AKASYA AVM - İSTANBUL  
DOĞA KOLEJİ - İSTANBUL  
HATEMOĞLU MAĞAZALARI - İSTANBUL  
KOSKA HELVA - İSTANBUL  
RAMADA HOTEL - İSTANBUL  
PALADIUM AVM - İSTANBUL  
PIAZZA ALIŞVERİŞ MERKEZİ - İSTANBUL  
STARBUCKS COFFEE - İSTANBUL  
WATSONS - İSTANBUL  
ŞİŞLİ STYLE HOTEL - İSTANBUL  
GÖNÜLHAN HOTEL - İZMİR  
WAY HOTEL - İZMİR  
THERMAL HOTEL - İZMİR  
DOĞA KOLEJİ - İZMİR  
EGE ÜNİVERSİTESİ ZİRAAT FAKÜLTESİ - İZMİR  
ÖĞRENCİ YURDU - İZMİR  
ALKOÇLAR HOTEL - İZMİR  
PALM PORT - İZMİR  
SİLLION ALIŞVERİŞ MERKEZİ - İZMİR  
SİENA EVLERİ - İZMİR  
KARŞIYAKA DEVLET HASTANESİ - İZMİR  
KONAK HOTEL - İZMİR  
RAMADA HOTEL - İZMİR  
MENEMEN HÜKÜMET BİNASI - İZMİR  
BAY KEPİ HOTEL - İZMİR  
EGE KOOPERATİF GULF EVLERİ - İZMİR  
NAVARA POLİKLİNİK - İZMİR  
ŞİFA ÜNİVERSİTE HASTANESİ - İZMİR  
KAYSERİ VERGİ DAİRESİ - KAYSERİ  
STARBUCKS COFFEE - KOCAELİ  
KOCAELİ BELEDİYESİ - KOCAELİ  
HALİL KALE FEN LİSESİ - MANİSA  
HASAN FERDİ ORTAOKULU - MANİSA  
KAHVE DİYARI - MANİSA  
PEKDEMİR ALIŞVERİŞ MERKEZİ - MANİSA  
POLİS MERKEZİ - MANİSA  
TURGUTLU DEVLET HASTANESİ - MANİSA

### NAME OF THE PROJECT

LAKRISHTE COMPLEX - KOSOVO  
SCHOOL PROJECT - AZERBAIJAN  
DREAM VILLA PROJECT - BULGARIA  
KATAMPE HOUSES - NIGERIA  
WATSONS STORES - ADAPAZARI  
GARANTI BANK - ADAPAZARI  
GRANADA HOTEL - ALANYA  
BASKENT UNIVERSITY - ANKARA  
ANKAMALL AVM - ANKARA  
KAYA HOTEL-ANTALYA  
WATER SIDE HOTEL-ANTALYA  
AKDENIZ UNIVERSITY - ANTALYA  
RIXOS HOTEL - ANTALYA  
FAUSTINA HOTEL- AYDIN  
THERMAL OTEL-AYDIN  
TEMİZEL HOTEL- BALIKESİR  
TEMİZEL VILLAS -BALIKESİR  
RAMADA HOTEL- BALIKESİR  
CARSI STORES- DENİZLİ  
ACIBADEM AKASYA AVM - ISTANBUL  
DOGA COLLEGE - ISTANBUL  
HATEMOGLU STORES - ISTANBUL  
KOSKA HELVA- ISTANBUL  
RAMADA HOTEL -ISTANBUL  
PALADIUM AVM-ISTANBUL  
PIAZZA SHOPPING MALL- ISTANBUL  
STARBUCKS COFFEE - ISTANBUL  
WATSONS STORES- ISTANBUL  
ŞİŞLİ STYLE HOTEL- ISTANBUL  
GONULHAN HOTEL-IZMİR  
WAY HOTEL-IZMİR  
THERMAL HOTEL- IZMİR  
DOGA COLLEGE -IZMİR  
EGE UNIVERSITY/FACULTY OF AGRICULTURE- IZMİR  
STUDENT DORMITORY -IZMİR  
ALKOCLAR HOTEL - IZMİR  
PALM PORT PROJECT- IZMİR  
SILLION SHOPPING CENTER-IZMİR  
SIENA HOUSES-IZMİR  
KARŞIYAKA STATE HOSPITAL - IZMİR  
KONAK HOTEL - IZMİR  
RAMADA HOTEL-IZMİR  
MENEMEN GOVERNMENT OFFICE-IZMİR  
BAY KEPI HOTEL -IZMİR  
EGE COOPERATIVE GULF HOUSES- IZMİR  
NAVARA POLYCLINICS -IZMİR  
SIFA UNIVERSITY HOSPITAL- IZMİR  
KAYSERİ TAX COLLECTOR'S OFFICE-IZMİR  
STARBUCKS COFFEE-KOCAELİ  
KOCAELİ MANUPICIALITY-KOCAELİ  
HALİL KALE SCIENCE HIGH SCHOOL - MANISA  
HASAN FERDİ COLLEGE-MANISA  
KAHVE DIYARI -MANISA  
PEKDEMİR SHOPPING MALL-MANISA  
POLICE HEADQUARTERS-MANISA  
STATE HOSPITAL -MANISA



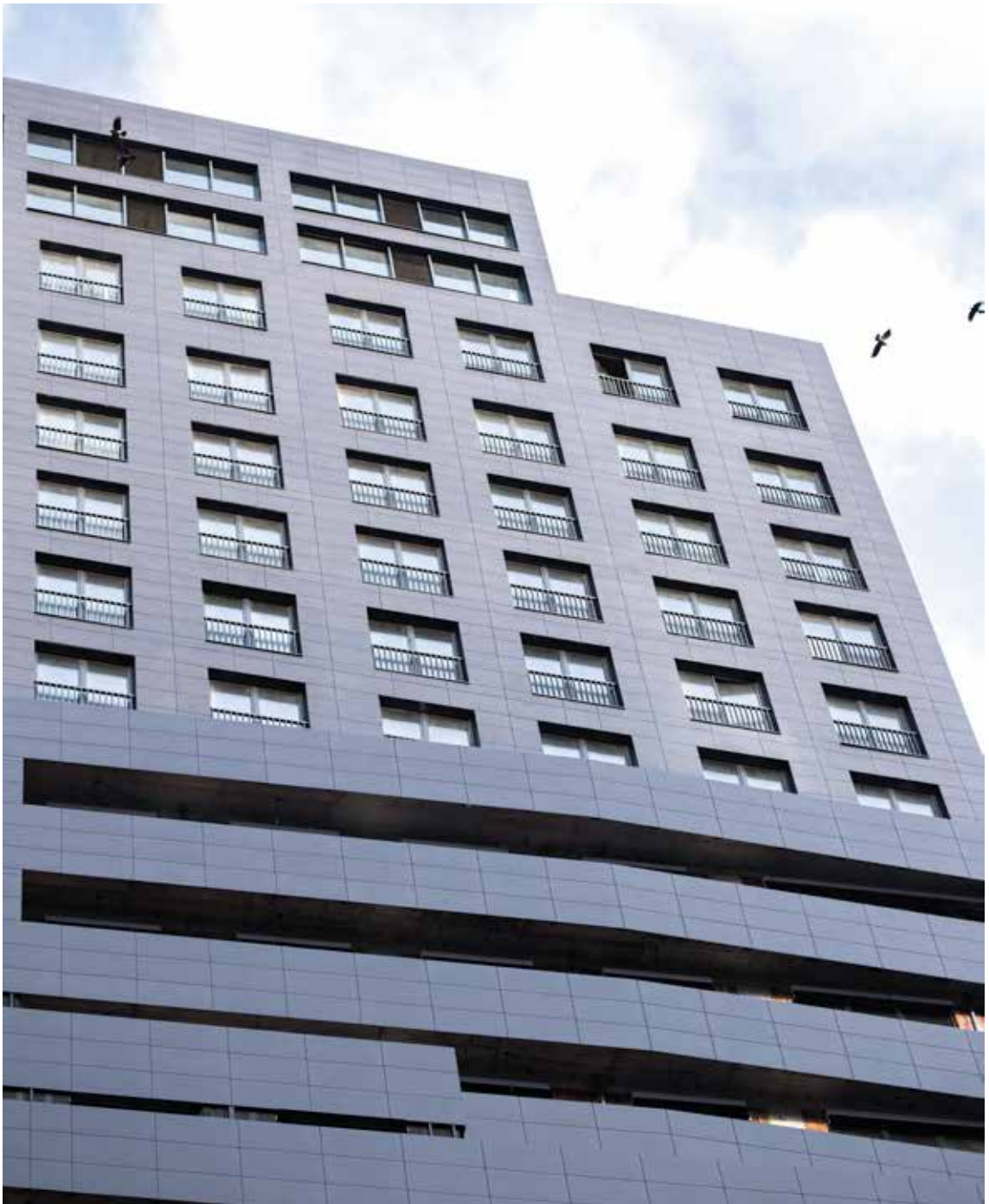

Lakrishte Kompleksi KOSOVA - Lakrishte Complex KOSOVO



## REFERANS PROJELER / REFERENCE PROJECTS

### PROJE ADI

8 EYLÜL HASTANESİ - MANİSA  
İSTİHDAM AJANSI - MANİSA  
ŞEHİRLER ARASI OTOBÜS TERİNALİ - MANİSA  
MİDYAT HOTEL - MARDİN  
MİNDAS VİLLALARI - MUĞLA  
MİDTOWN AVM - STARBUCKS COFFEE - MUĞLA  
SIIRT ÜNİVERSİTESİ - SIIRT  
BAY DÖNER RESTAURANTLARI - İSTANBUL  
ALFEMO MAĞAZALARI - İSTANBUL  
KİLİM MAĞAZALARI - İSTANBUL  
LC WAIKIKI MAĞAZALARI - İSTANBUL  
MADAME COCO MAĞAZALARI - İSTANBUL  
SEVEN HİLL MAĞAZALARI - İSTANBUL  
KONUT PROJESİ - TÜRKMENİSTAN  
BASKI EVİ PROJESİ - TÜRKMENİSTAN  
FLO MAĞAZALARI - İSTANBUL  
İYAŞ PARK AVM - İSPARTA  
POLARİS MAĞAZASI-NEOMARİNE AVM - İSTANBUL  
DENİZBANK - İSTANBUL - İSTANBUL  
LİTTLE CAESARS - ANKARA  
LİTTLE CAESARS - GAZİANTEP  
LİTTLE CAESARS - BURSA  
LİTTLE CAESARS - İSTANBUL  
LİTTLE CAESARS - KOCAELİ  
LİTTLE CAESARS - BALIKESİR  
TEB BANKASI - İSTANBUL  
ODEABANK - İSTANBUL  
ODEABANK - SAMSUN  
ZARA MAĞAZALARI - İSTANBUL  
ZARA MAĞAZALARI - BURSA  
ZARA MAĞAZALARI - SAMSUN  
ZARA MAĞAZALARI - ANKARA  
ZARA MAĞAZALARI - ADANA  
MEKTEBİM KOLEJİ - İSTANBUL  
BİLFEN EĞİTİM KURUMLARI - İZMİR  
BİLFEN EĞİTİM KURUMLARI - İSTANBUL  
OPTİMUM AVM - İSTANBUL  
QUASAR REZİDANS - İSTANBUL  
SOYAK KONFORİA - İSTANBUL  
ÇEKMEKÖY DEVLET HASTANESİ - İSTANBUL  
WEST SİDE PROJESİ - İSTANBUL  
EGAL İSTANBUL - İSTANBUL  
YEDİTEPE ÜNİVERSİTESİ ONKOLOJİ HASTANESİ - İSTANBUL  
TORUNLAR TOWER - İSTANBUL  
BROOKLYN PARK - İSTANBUL  
AHENK KONAKLARI - İSTANBUL  
ATAKENT HASTANESİ - İSTANBUL  
SAKARYA ÜNİVERSİTESİ TEKNOLOJİ FAKÜLTESİ - ADAPAZARI  
PELICAN HİLL EVLERİ - İSTANBUL  
CASA MARGOT HOTEL - MUĞLA  
ENKA YAPI - IRAK  
TEMA İSTANBUL - İSTANBUL  
DURU PARK EVLERİ - İSTANBUL  
MUSTAFA SAFFET KÜLTÜR MERKEZİ - İSTANBUL  
TERAS MODA ADALAR - İSTANBUL  
BEYKOZ BELEDİYESİ - İSTANBUL

### NAME OF THE PROJECT

8 EYLUL HOSPITAL-MANISA  
EMPLOYMENT AGENCY BUILDING-MANISA  
MAIN BUS STATION -MANISA  
MIDYAT HOTEL-MANISA  
MINDAS VILLAS-MUGLA  
MIDTOWN AVM - STARBUCKS COFFEE-MUGLA  
UNIVERSITY OF SIIRT-SIIRT  
"BAY DONER" RESTAURANTS CHAIN -ISTANBUL  
ALFEMO STORES-ISTANBUL  
KILIM STORES-ISTANBUL  
LC WAIKIKI STORES-ISTANBUL  
MADAME COCO STORES -ISTANBUL  
SEVEN HILL STORES -ISTANBUL  
HOUSING PROJECT-TURKMENISTAN  
PRINTING HOUSE PROJECT-TURKMENISTAN  
FLO STORES-ISTANBUL  
IYAS PARK SHOPPING MALL - ISPARTA  
POLARIS - NEOMARINE AVM-ISTANBUL  
DENIZBANK - ISTANBUL  
LITTLE CAESARS - ANKARA  
LITTLE CAESARS - GAZIANTEP  
LITTLE CAESARS - BURSA  
LITTLE CAESARS - ISTANBUL  
LITTLE CAESARS - KOCAELI  
LITTLE CAESARS - BALIKESIR  
TEB BANK -ISTANBUL  
ODEABANK-ISTANBUL  
ODEABANK-SAMSUN  
ZARA STORES-ISTANBUL  
ZARA STORES-BURSA  
ZARA STORES-SAMSUN  
ZARA STORES-ANKARA  
ZARA STORES-ADANA  
MEKTEBIM COLLEGE-ISTANBUL  
BILFEN EDUCATIONAL INSTITUTIONS-IZMIR  
BILFEN EDUCATIONAL INSTITUTIONS-ISTANBUL  
OPTIMUM SHOPPING MALL -ISTANBUL  
QUASAR RESIDENCE-ISTANBUL  
SOYAK KONFORIA-ISTANBUL  
ÇEKMEKÖY STATE HOSPITAL-ISTANBUL  
WEST SIDE PROJECT-ISTANBUL  
EGAL ISTANBUL-ISTANBUL  
YEDITEPE UNIVERSITY ONCOLOGY HOSPITAL-ISTANBUL  
TORUNLAR TOWER-ISTANBUL  
BROOKLYN PARK -ISTANBUL  
AHENK KONAKLARI-ISTANBUL  
ATAKENT HOSPITAL - ISTANBUL  
SAKARYA UNIVERSITY FACULTY OF THEOLOGY-ADAPAZARI  
PELICAN HILL HOUSES-ISTANBUL  
CASA MARGOT HOTEL-MUĞLA  
ENKA BUILD- IRAQ  
TEMA ISTANBUL - ISTANBUL  
DURU PARK HOUSE - ISTANBUL  
MUSTAFA SAFFET CULTURAL CENTER-ISTANBUL  
TERAS MODA ADALAR-ISTANBUL  
BEYKOZ MANUPICIALITY- ISTANBUL



Lakrishte Kompleksi KOSOVA - Lakrishte Complex KOSOVO

## BÖLGE SATIŞ YÖNETİCİLERİ

### İZMİR I

Aydın, Denizli, İzmir, Manisa (Alaşehir, Demirci, Salihli, Turgutlu)  
Tel: 0533 594 66 35

### İZMİR II

İzmir ( Karşıyaka, Buca, Menemen, Foça, Çiğli, Aliağa, Dikili, Bergama), Balıkesir (Ayvalık, Burhaniye, Edremit), Çanakkale (Küçükkuyu)  
Tel: 0533 594 66 52

### İZMİR III

İzmir (Balçova, Çeşme, Karaburun, Seferihisar, Urla, Yenisehir, Manisa (Akhisar, Soma)  
Tel: 0530 310 95 57

### İZMİR IV

İzmir (Armutlu, Çamdibi, Gaziemir, Kemalpaşa, Pınarbaşı, Muğla)  
Tel: 0533 594 66 53

### İSTANBUL (AVRUPA) I

İst. (Avr), Edirne, Kırklareli, Tekirdağ  
Tel: 0533 594 66 56

### İSTANBUL (AVRUPA) II

İst. (Avr)  
Tel: 0549 727 23 64

### İSTANBUL (ANADOLU) I

İst. (And),  
Tel: 0549 791 48 65

### İSTANBUL (ANADOLU) II

İst. (And), Adapazarı, Bartın, Bolu, Düzce, İzmit, Karabük, Zonguldak  
Tel: 0533 594 66 58

### ANKARA

Ankara, Çankırı, Kırıkkale  
Tel: 0533 594 66 48

### BURSA I

Bursa, Balıkesir, Çanakkale  
Tel: 0533 594 66 55

### BURSA II

Bursa, Bilecik, Eskişehir, Kütahya, Uşak, Yalova  
Tel: 0533 129 82 23

### ADANA

Adana, Antakya, Kahramanmaraş, Kilis, Osmaniye  
Tel: 0533 705 73 38

### DİYARBAKIR

Batman, Bingöl, Bitlis, Diyarbakır, Hakkari, Mardin, Muş, Siirt, Şırnak, Van  
Tel: 0533 594 66 54

### ERZURUM

Ağrı, Ardahan, Erzincan, Erzurum, Iğdır, Kars  
Tel: 0530 063 67 75

### GAZİANTEP

Adıyaman, Elazığ, Gaziantep, Malatya, Şanlıurfa, Tunceli  
Tel: 0533 594 66 44

### KAYSERİ

Kayseri, Kırşehir, Nevşehir, Yozgat  
Tel: 0533 129 82 18

### KONYA - ANTALYA

Afyon, Antalya, Burdur, Isparta, Karaman, Konya  
Tel: 0533 129 82 19

### MERSİN

Aksaray, Niğde, Mersin  
Tel: 0533 594 66 41

### SAMSUN

Amasya, Çorum, Kastamonu, Samsun, Sinop, Sivas, Ordu, Tokat  
Tel: 0533 594 66 45

### TRABZON

Artvin, Bayburt, Giresun, Gümüşhane, Rize, Trabzon  
Tel: 0533 594 66 47

### Kurumsal Müşteri ve Projeler Yöneticisi

Tel: 0533 594 66 59